

980722

1.

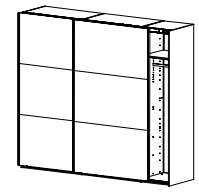

2.

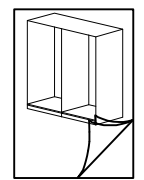
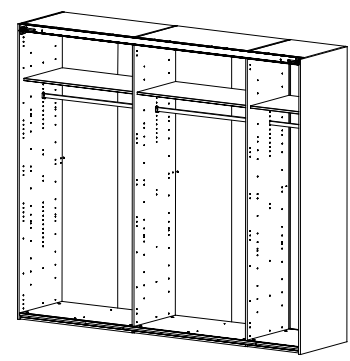
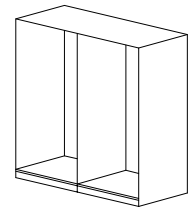



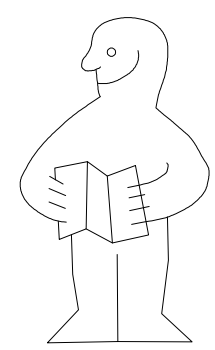
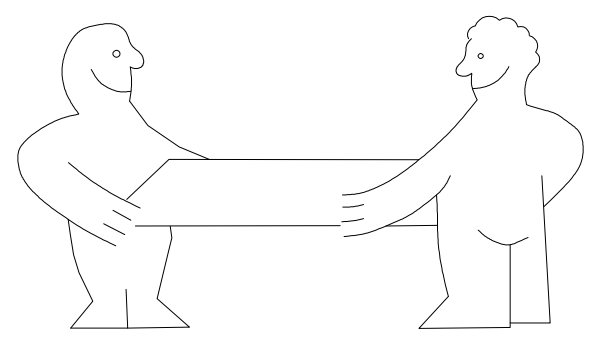
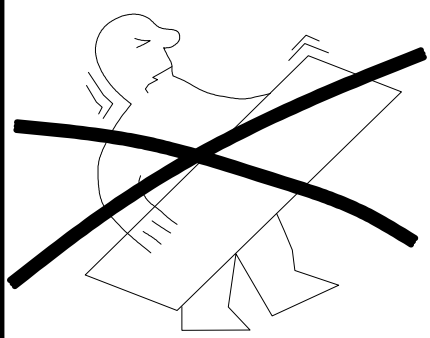

HSP 250

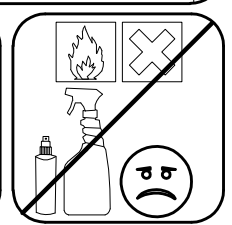
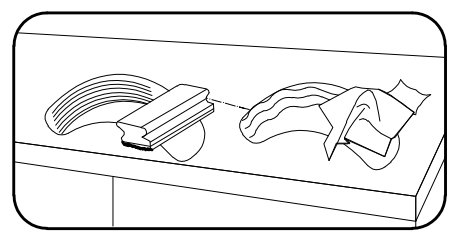
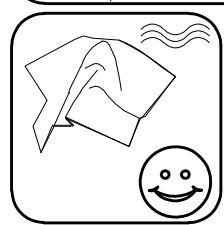
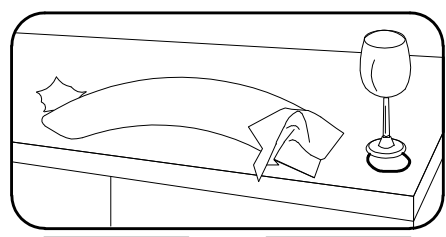
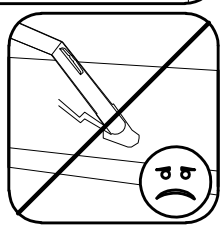
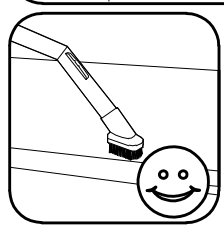
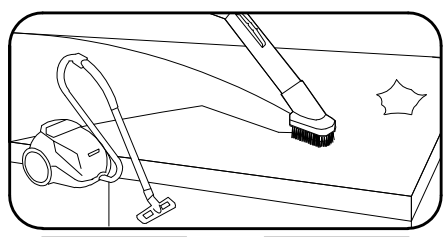
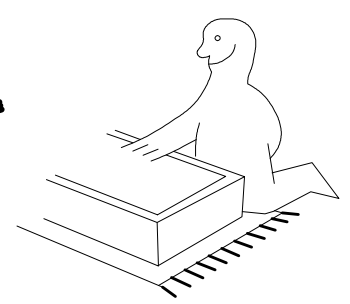
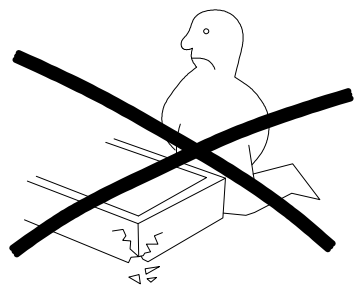
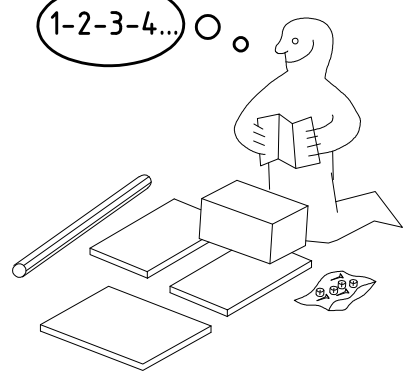

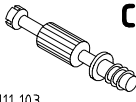

1-2-3-4... ○



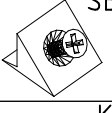
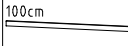

 111 xxx	A1	24x
 111 103	C	8x
	F3	8x

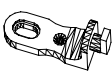
 111 xxx	S0	14x
 111 xxx ø12	V12	14x
 121 370 3,5 x 15 mm	G1	40x



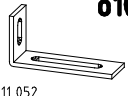

 117 002	K2	6x
	SBV	20x
 100cm 112 400	K10	2x

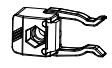

 111 611	J2	8x
 112 055 6,3 x 10,5 mm	T1	34x
 111 607	L8	12x

 111 052	o10	1x
 121 120 4 x 15mm	SP15	3x
 112 401 50cm	K11	1x

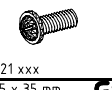
1x **FPK**  
14.53/1940/2430/2920/3408

1x **SWT-LP**  
14.53/1940/2430/2920/3410 SY

 121 xxx	SWT-ST	2x
 121 xxx M4 x 13 mm	SWT-SM5 GH13	2x
 121 xxx M4 x 10 mm	G43	6x
 121 xxx 3,5 x 35 mm	G14	6x
 121 375	G14	2x

 121 004	SWH-SKL	1x
 121 004 3,5 x 22 mm	SWH-SKR G24	1x
	G24	9x

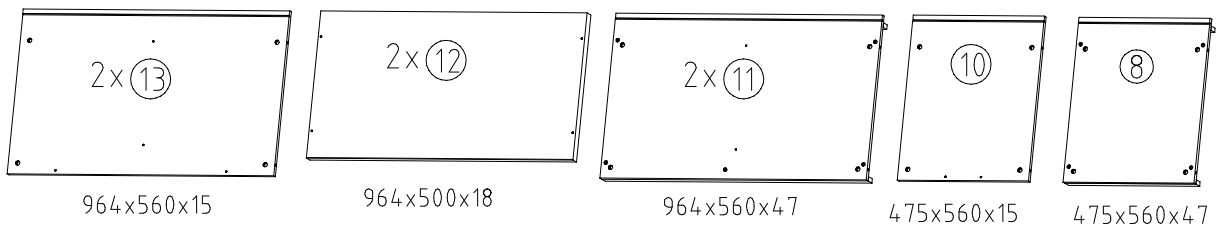
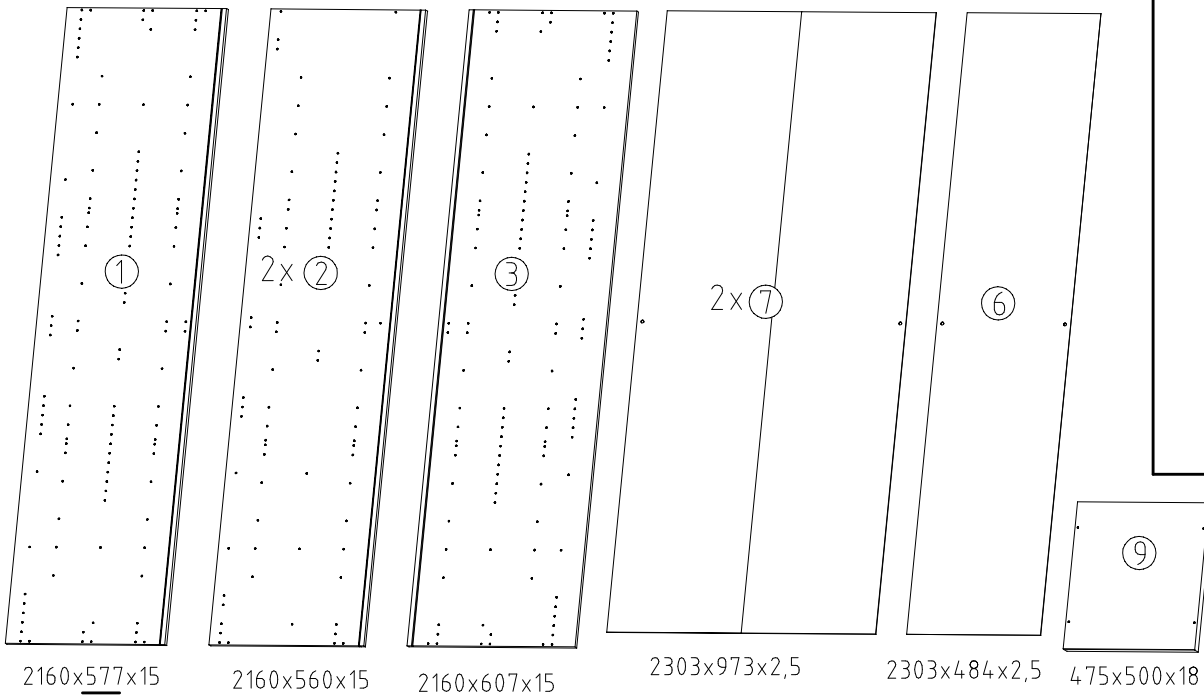
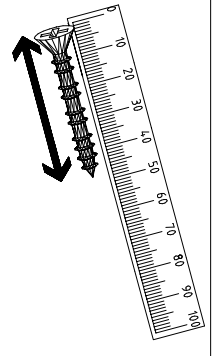
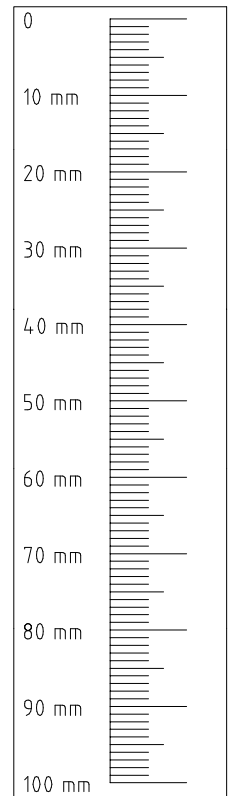
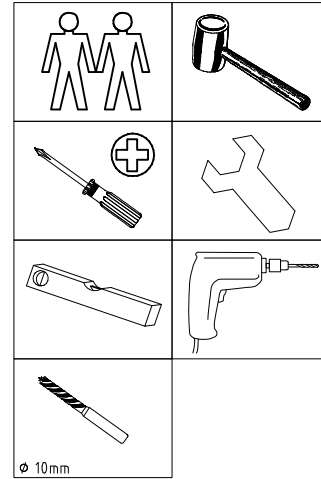

1

3,5 x 15 mm

G1



121 370

S0

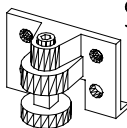

111 xxx

A1



111 xxx

3

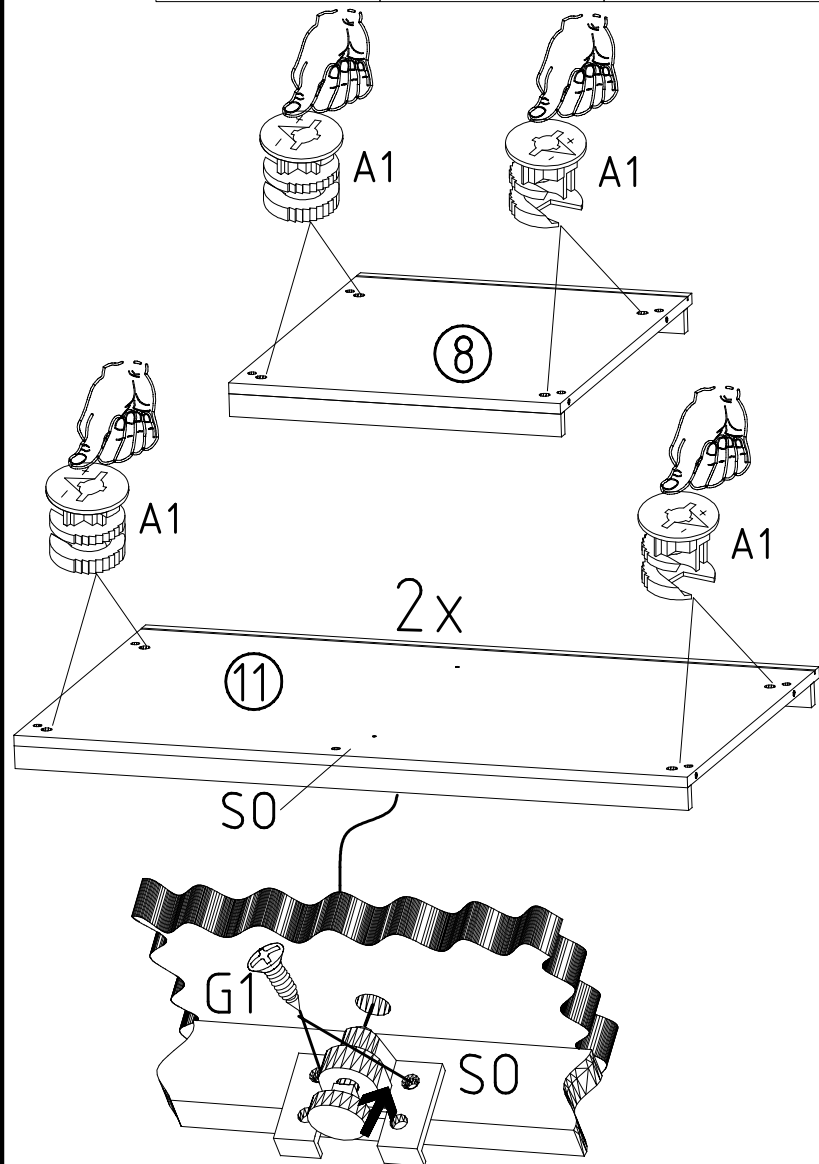

2

A1

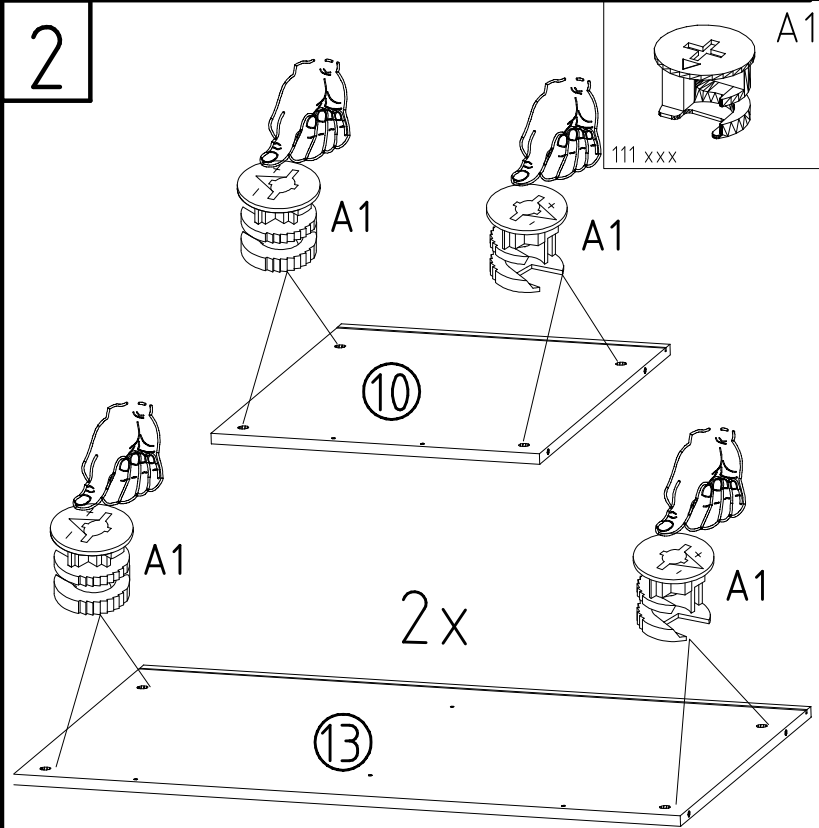

F3

② 2x

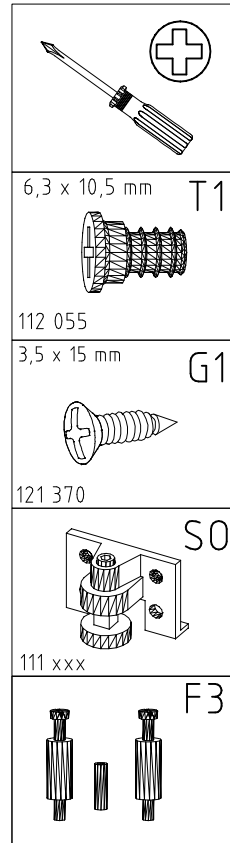

S0 F3 S0

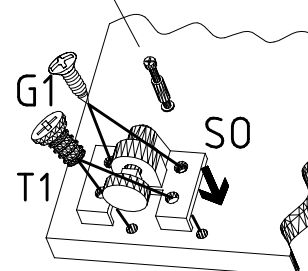
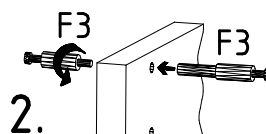
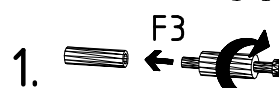

4

SWH-SKL

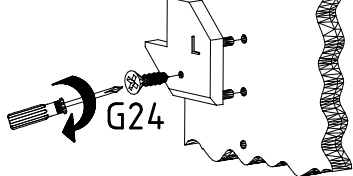

SWH-SKR

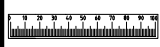
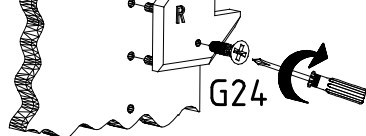

577

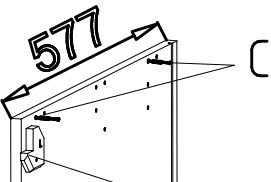

SWH-SKL + G24

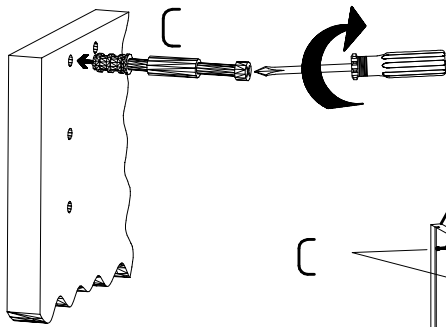

607

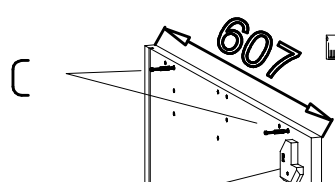

SWH-SKR + G24

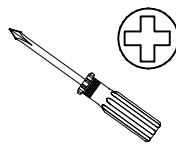

SWH-SKL

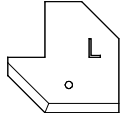

SWH-SKR

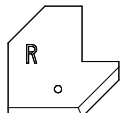

3,5 x 22 mm G24

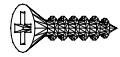

121 004

6,3 x 10,5 mm T1

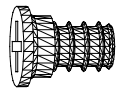

112 055

3,5 x 15 mm G1

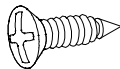

121 370

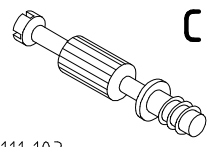

111 103

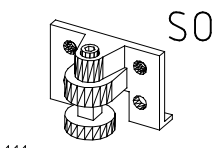

111 xxx

1

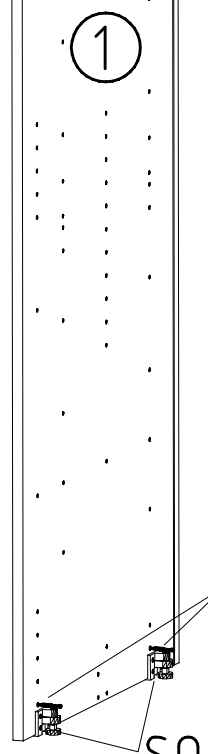

3

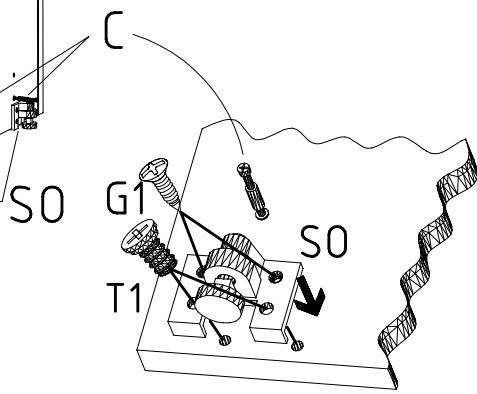
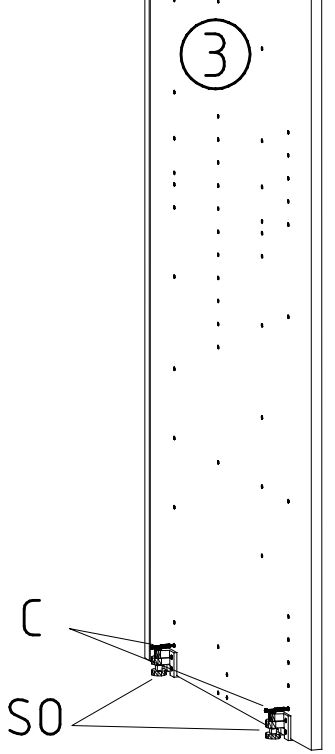

5

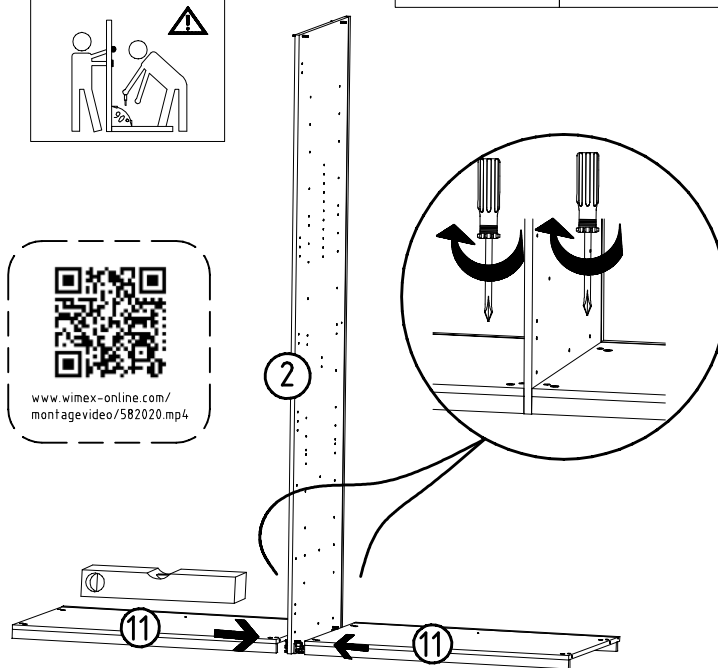
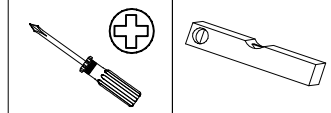

6

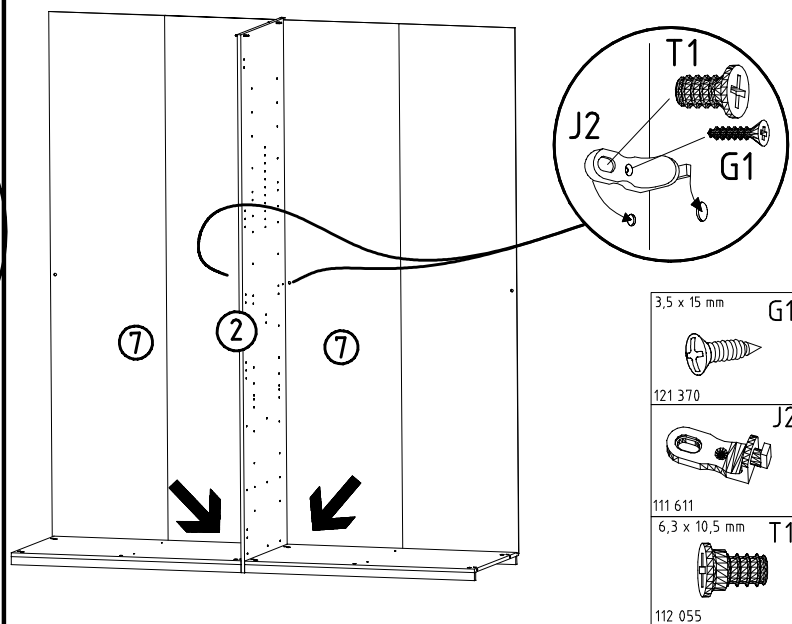
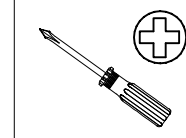

7

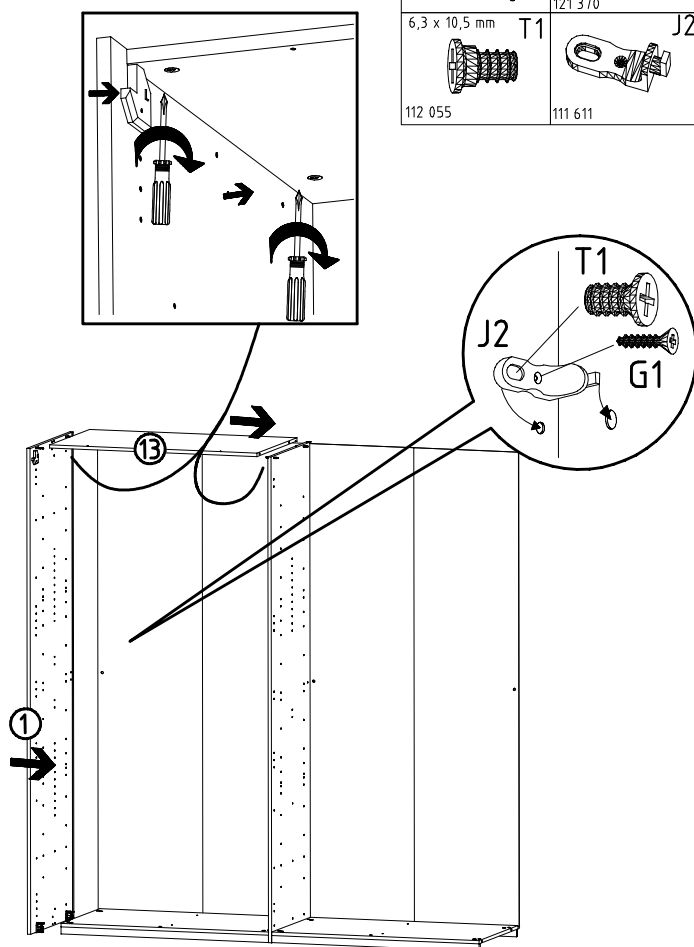
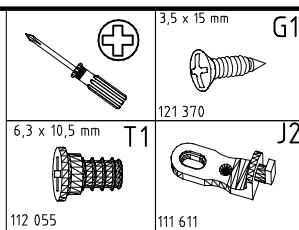

8

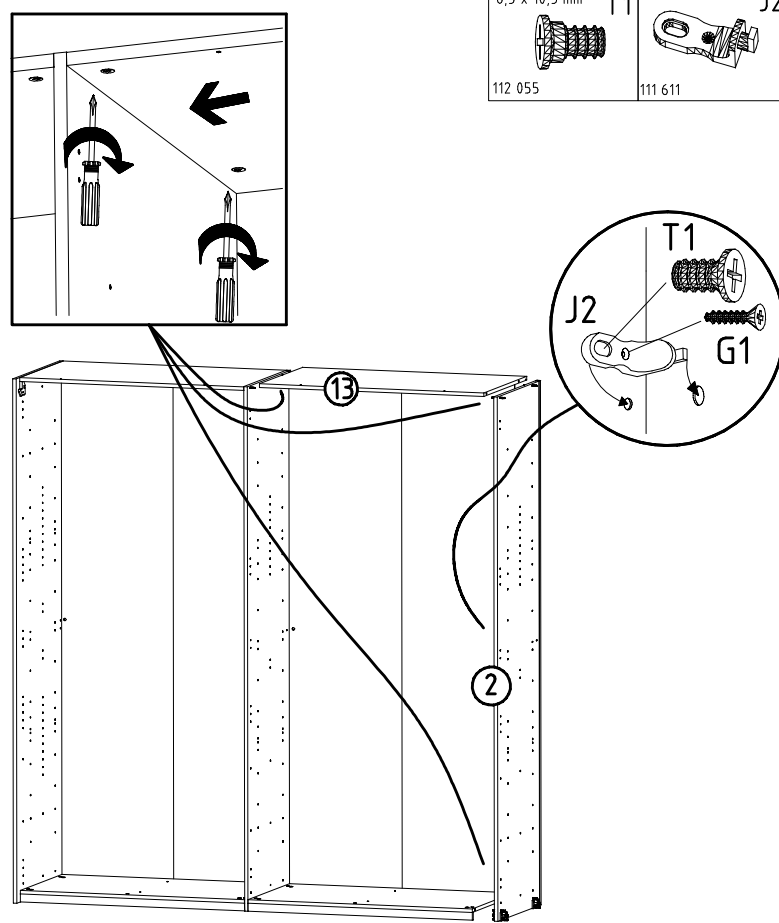
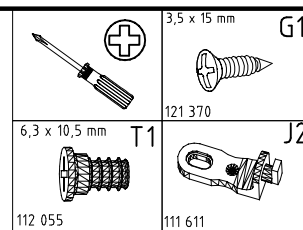

9

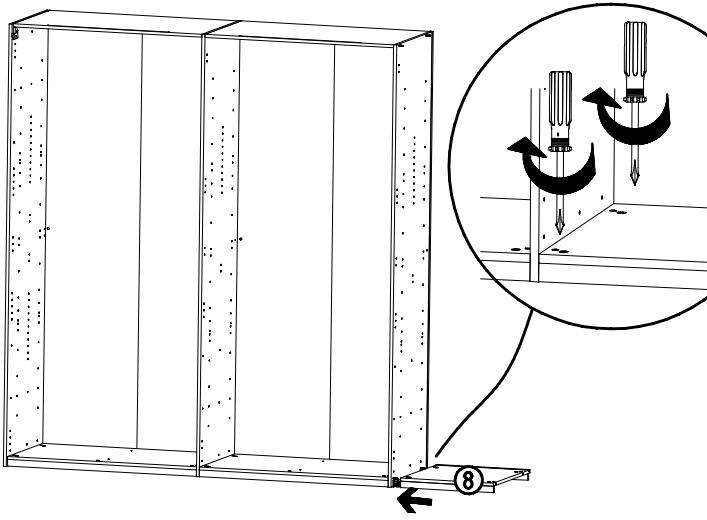
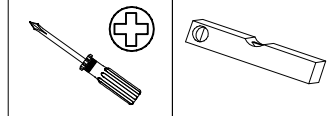
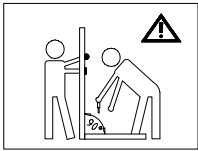

10

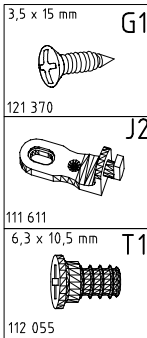
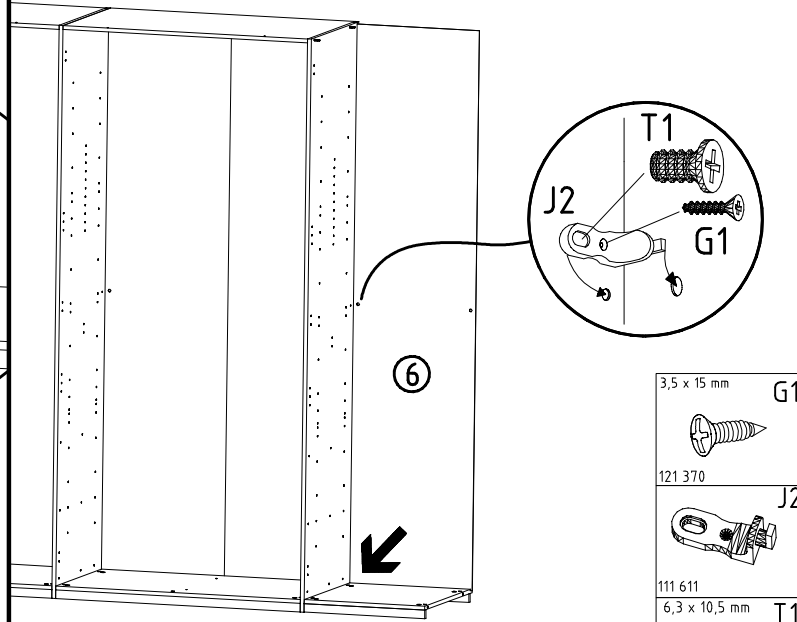
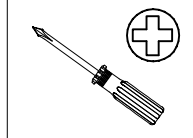

11

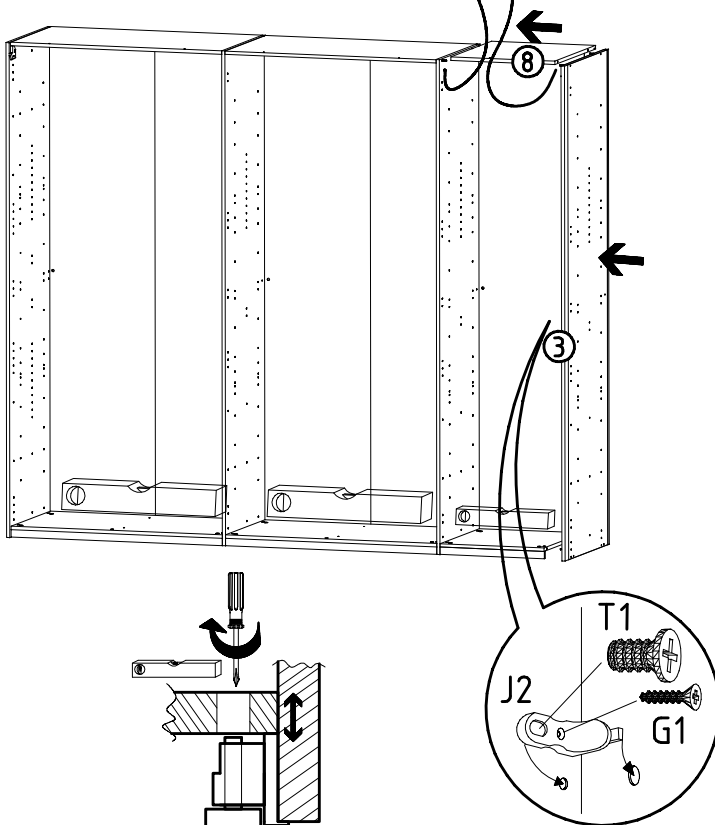
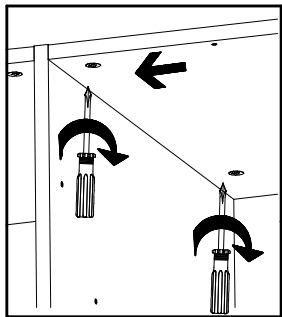
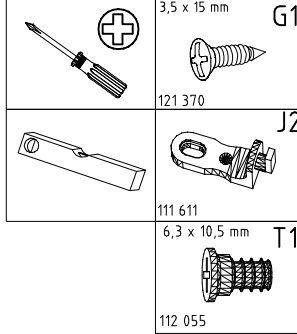

12

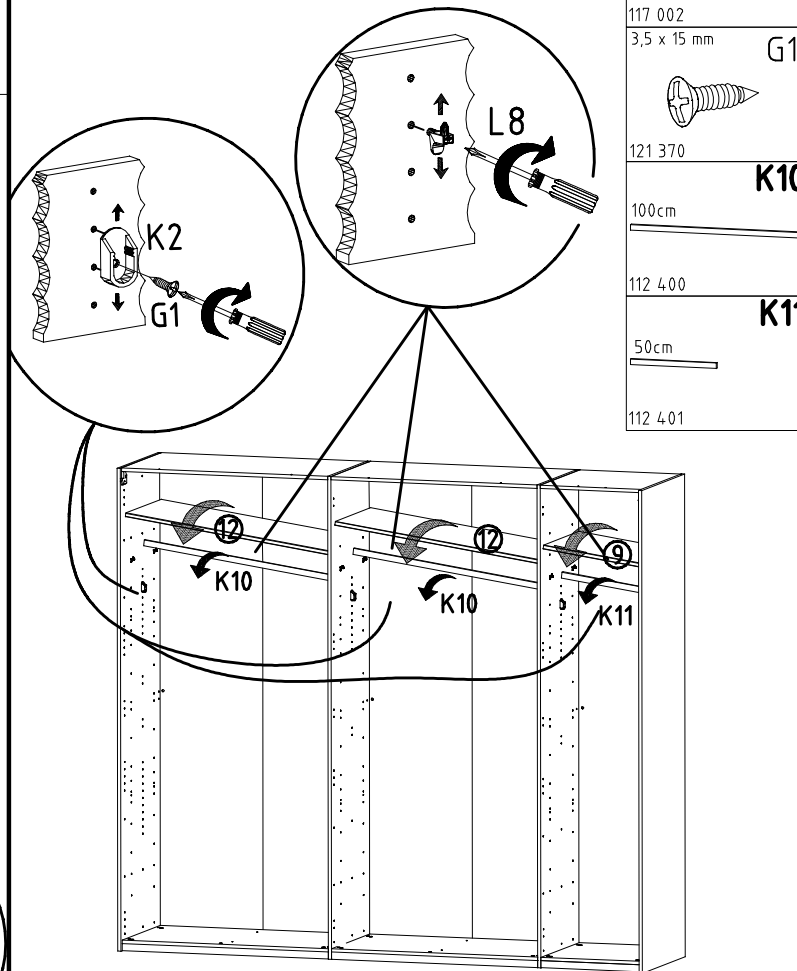
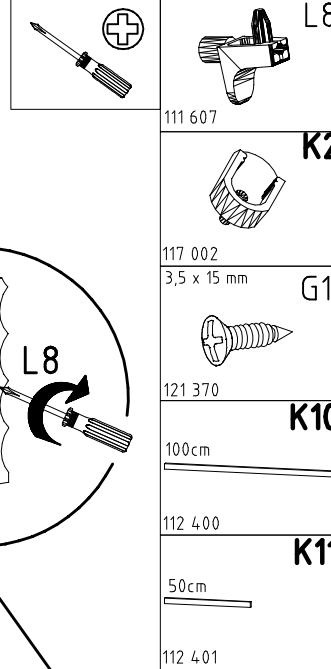

980722

12.12.16 / 10.02.17

02 17

6/11

13

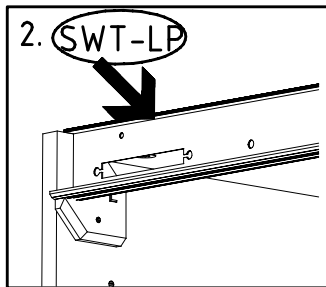
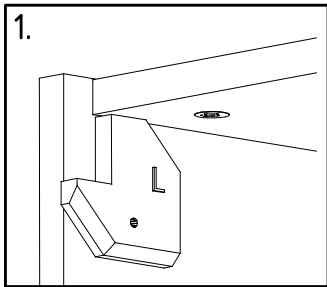

M4 x 10 mm G43 121 xxx	M4 x 13 mm GH13 121 xxx	3,5 x 35 mm G14 121 375	SWT-ST	SWT-SM5
------------------------------	-------------------------------	-------------------------------	--------	---------

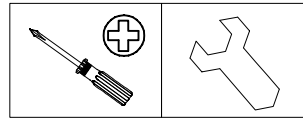
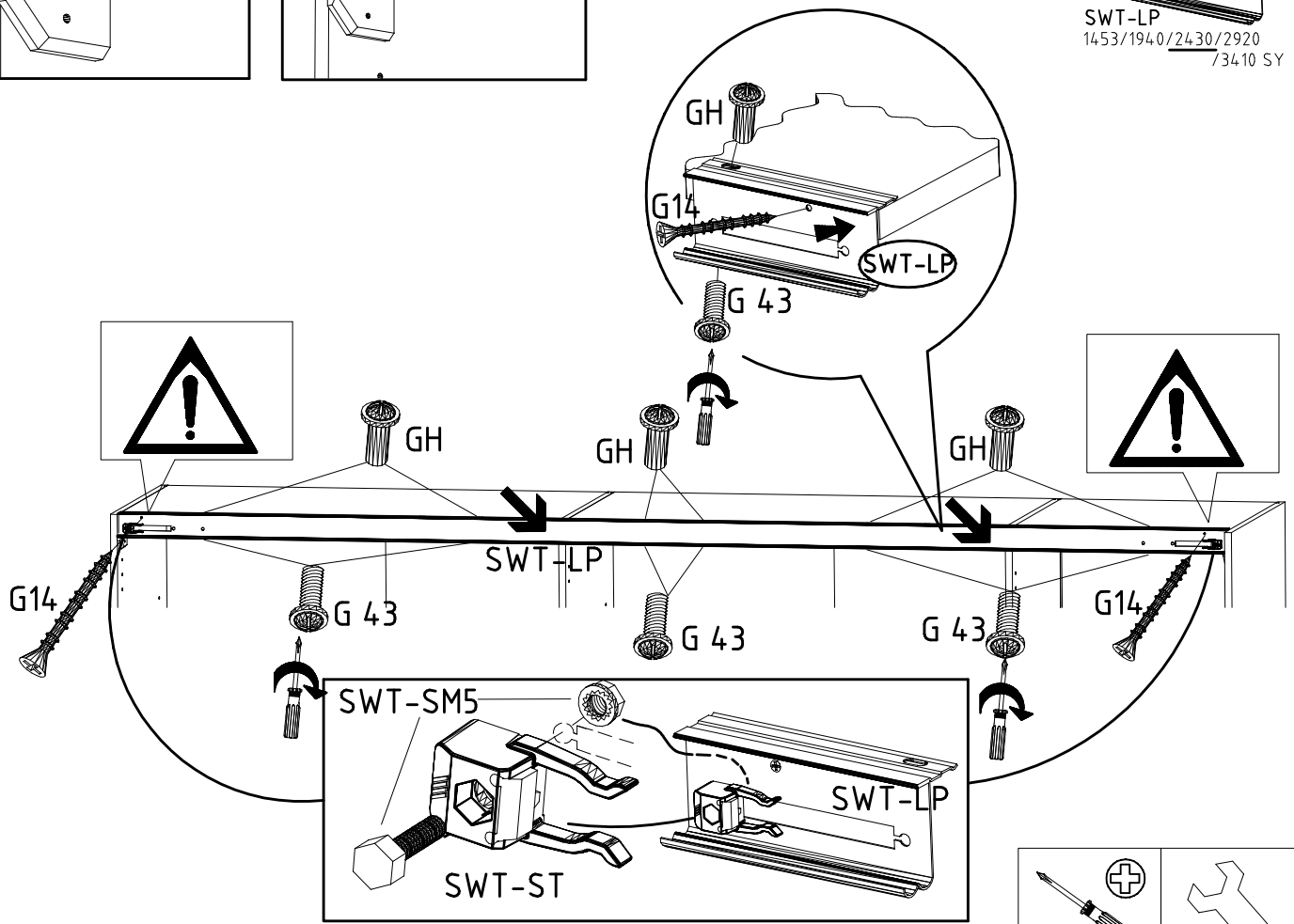
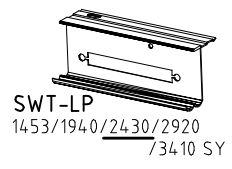

14

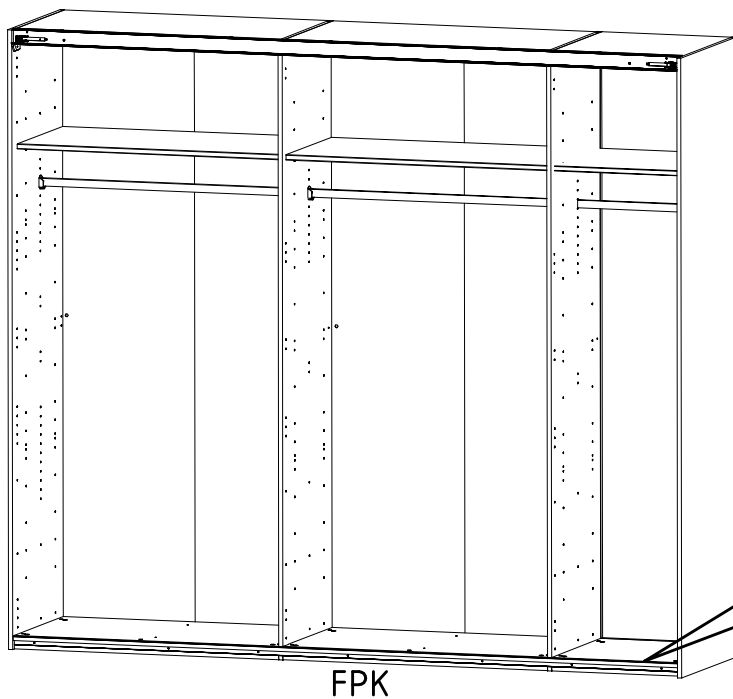

FPK 1453/1940/2430/2920/3408
3,5 x 22 mm G24 121 004

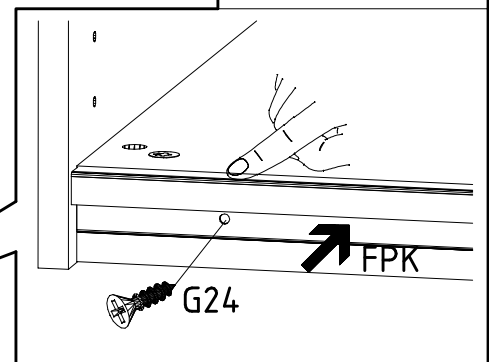

15

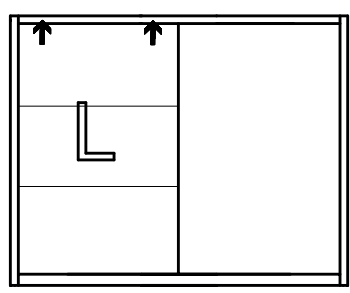
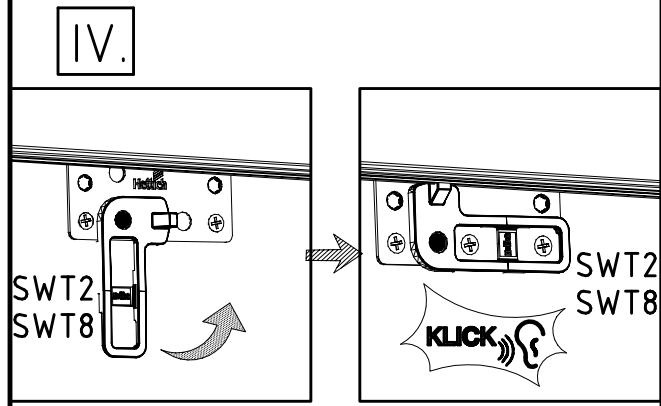
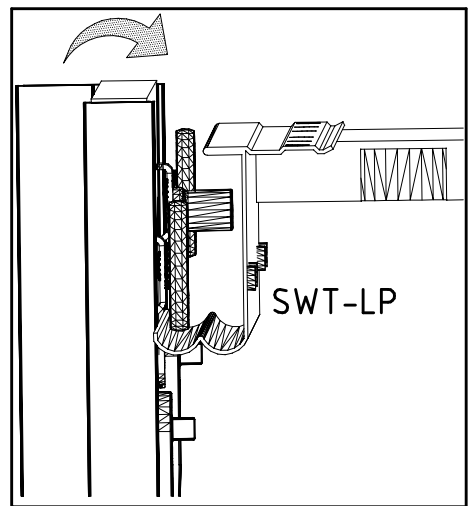
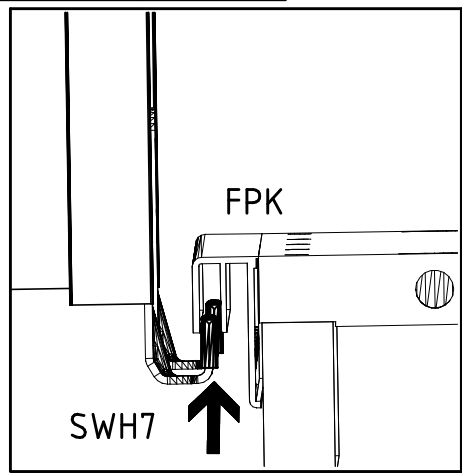
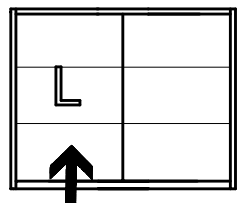
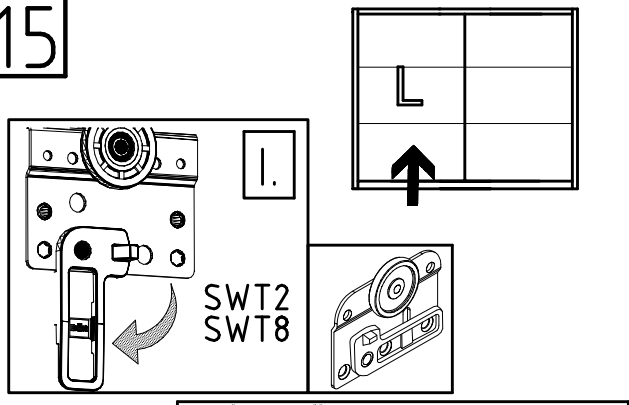

16

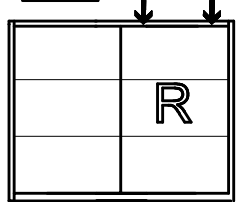
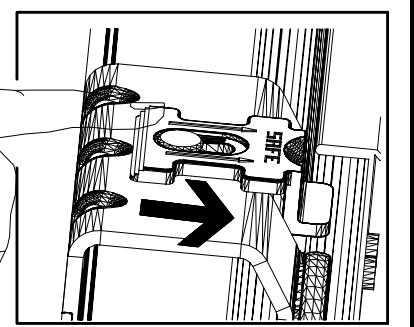
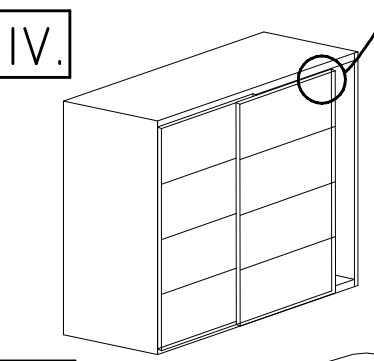
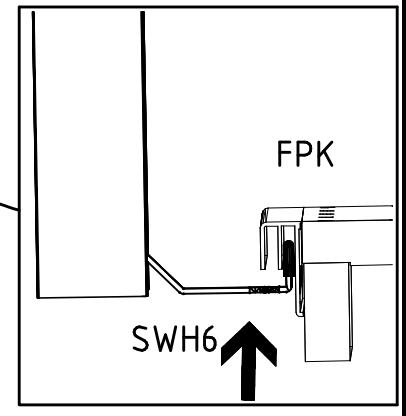
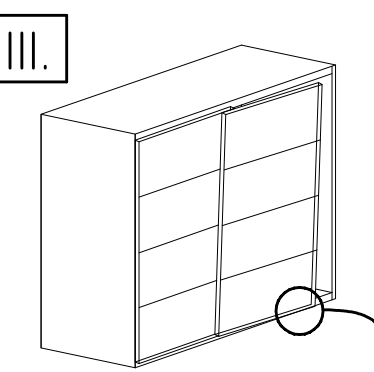
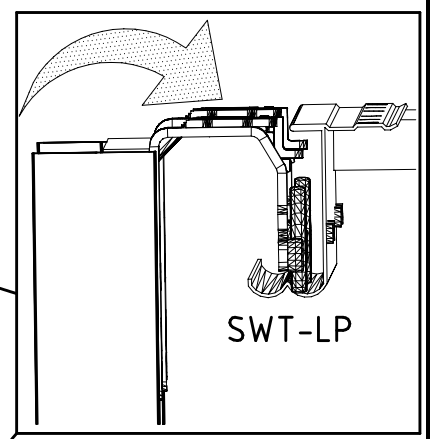
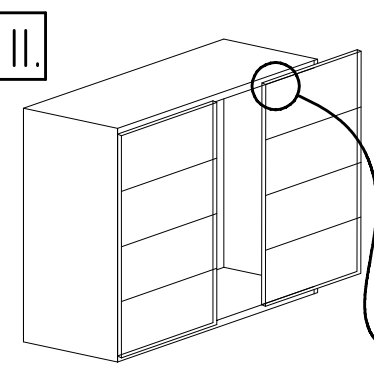
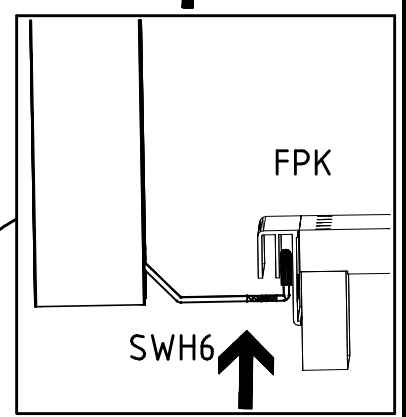
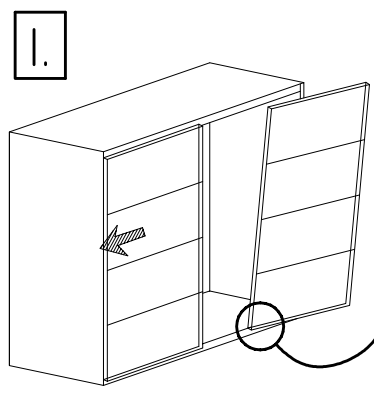
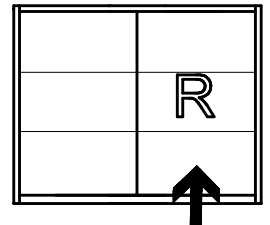
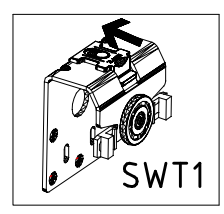



17

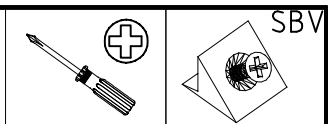
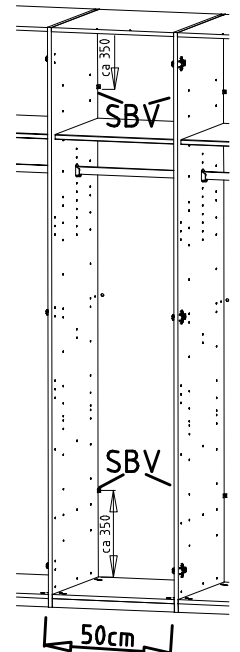
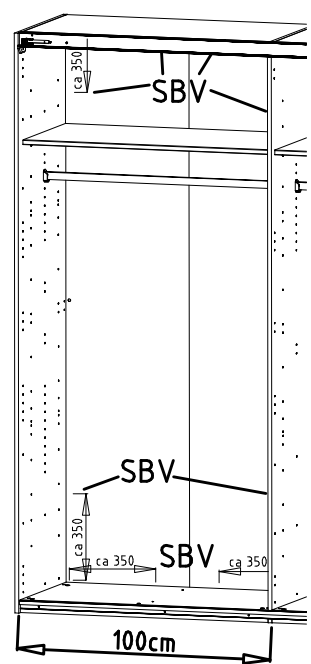
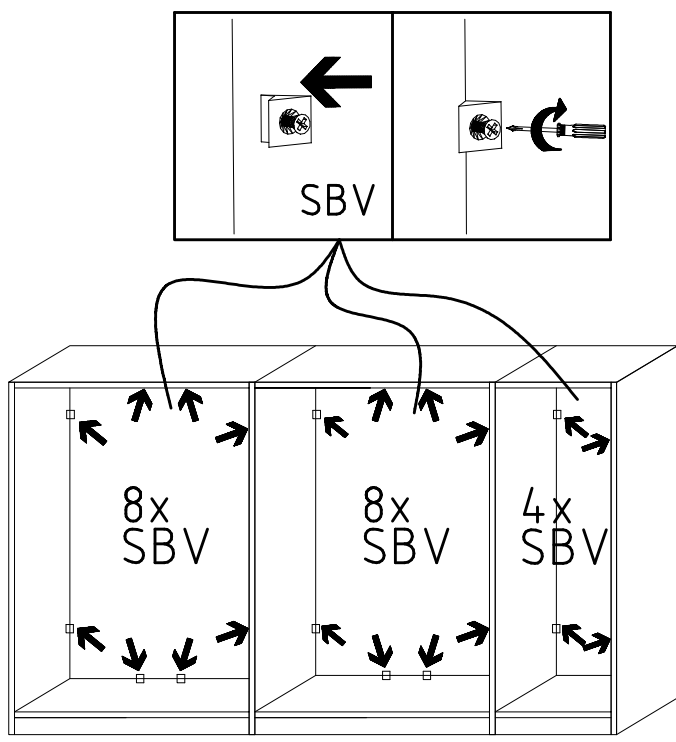

18

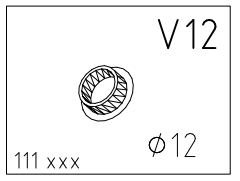
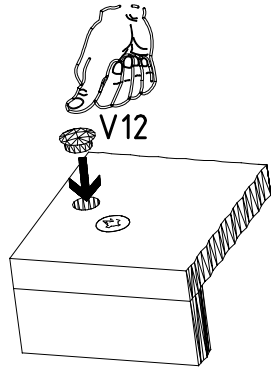
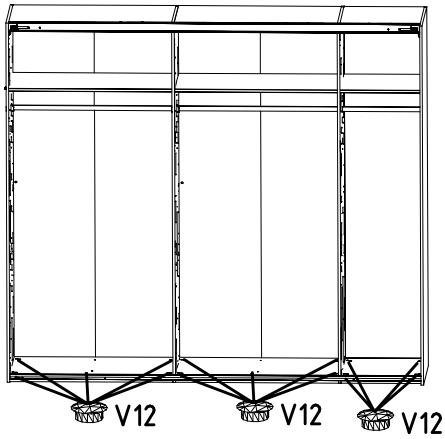

19

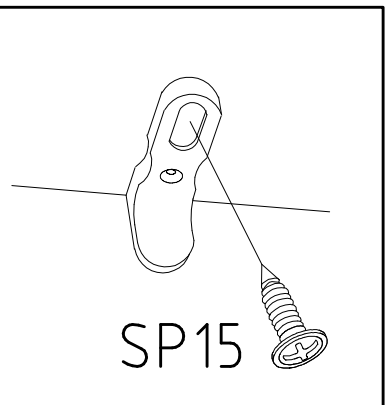
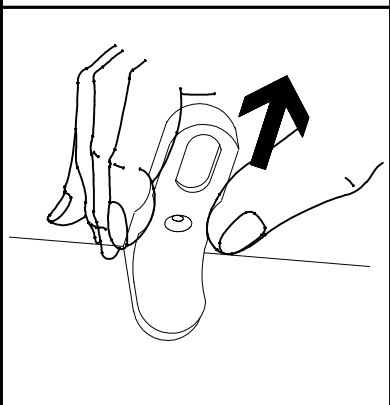
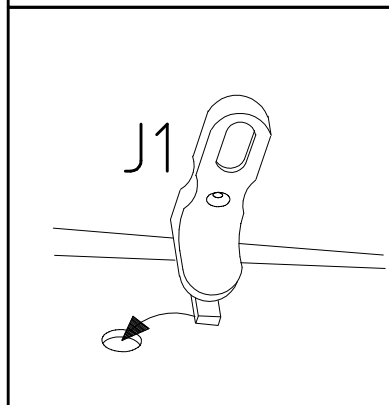
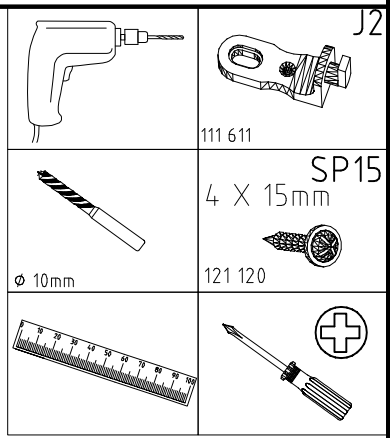
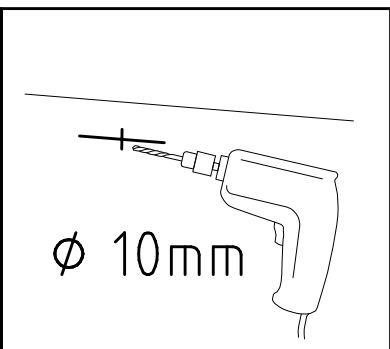
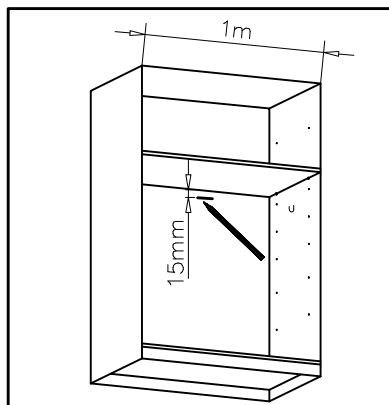

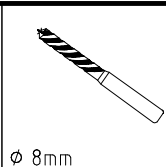
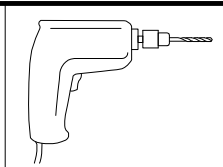

ø 8mm

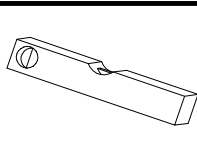
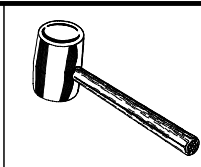

SP15  
4 X 15mm  
121 120

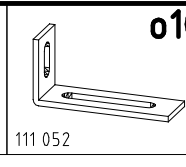

ø10

111 052

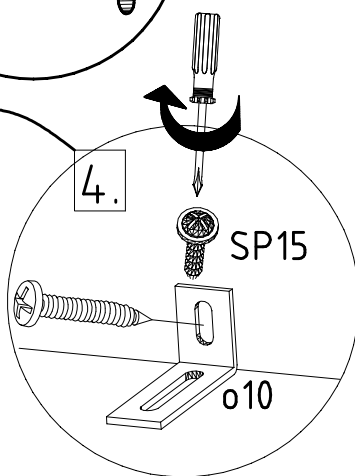
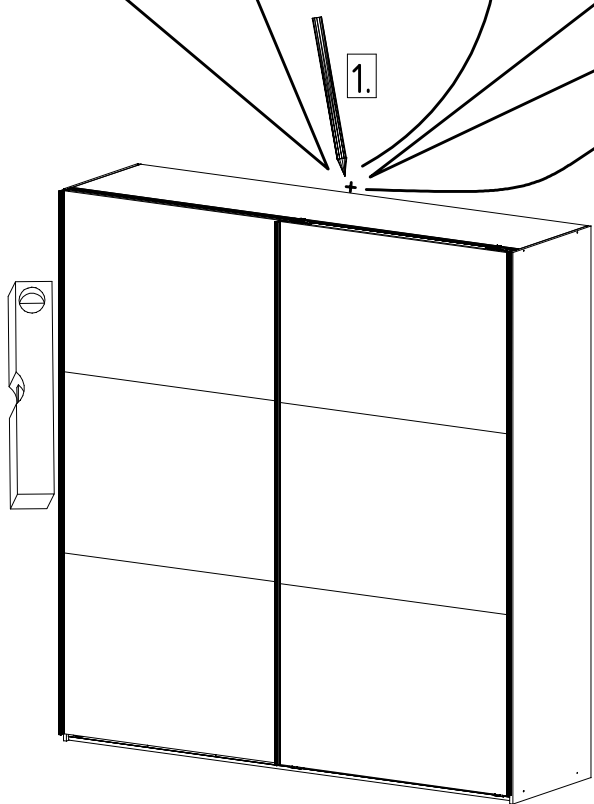
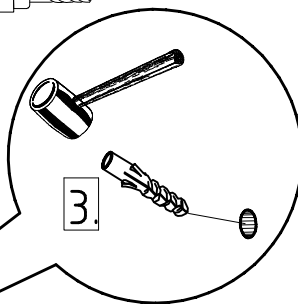
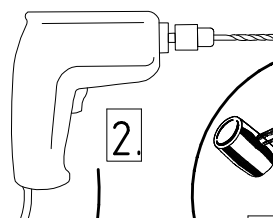
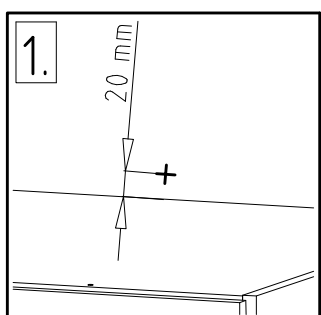
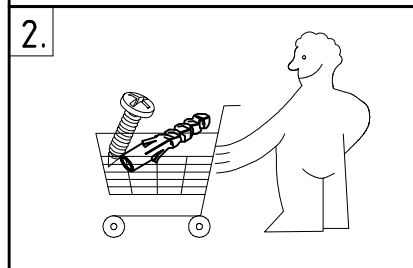
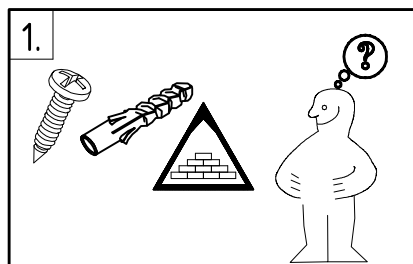

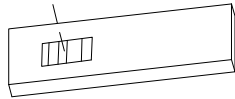
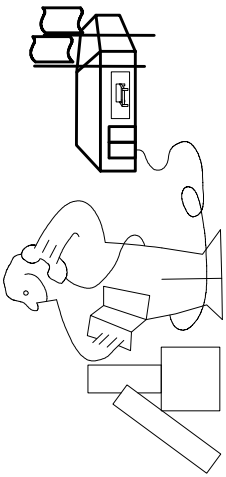
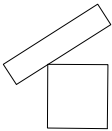
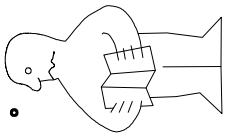

Modell/Model/Modèle

\_\_\_\_\_

\_\_\_\_\_

\_\_\_\_\_



\_\_\_\_\_

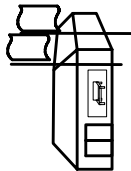

\_\_\_\_\_

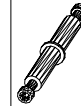
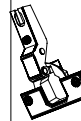
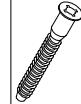

{121 370}	{ G 1 }	{4x}

Änderungen die dem technischen Fortschritt geschuldet sind, behalten wir uns vor !

Bei nicht vorschriftsmäßiger und/ oder nicht fachmännischer Montage wird bei Personen- und/ oder Sachschäden keinerlei Haftung übernommen.

WIMEX Wohnbedarf/ Import Export Handels GmbH/ Postfach 1407/ 49112 Georgsmarienhütte/ Germany  
Tel.:(+49) 05401 8598 72 Fax.:(+49) 05401 8598 33 Mail: service\_H@wimex-online.com

104P-NR. / 104P-NO.    150X-NR. / 150X-NO.    Auftrag/Order-No. / No. de Commande

**23203**    **30110XY**    104

Kunde    MAX MUSTERMANN  
Customer  
Client

Kommission / your order reference / votre reference

**3377 MINDEN**

---

Dekor / Decor    Decor / Modell / Modele

**F99**    **SAMPLE**

F99842 SCHWEBETUERENSCHRANK 250 CM H 216CM  
PLANKENEICHE NB + RAU STEEL  
PLANKENEICHE NACHBILDUNG

202320301107241476000001

Paket / Package / Paquet

**414760**

SOCKEL

Paket 1 von 8    Colli Kommission 10

HSP-SMT BOD 50 TEXT/TEX SOCKEL 32 FRESH    TV / LF 104  
SO-BOD TEXT RASTEX/ ZNBOD D18MM TX KLSTA

Montage - Anleitung    Laenge ..... 520,0    OBEREN  
KS-64    Breite ..... 568,0    OBEREN

**SOCKEL32 KLEB**

En cas de dommage, veuillez retourner le carton avec le produit. En cas de dommage, veuillez retourner le carton avec le produit.



OBEREN 5 30/19 HAUT 23.08.19 OBEREN 1 1. ABOVE OBEREN



**WIMEX Wohnbedarf**  
Import Export Handelsges mbH & Co. KG  
Werner-von-Siemens-Str. 35  
D-49124 Georgsmarienhütte - Germany

**SAMPLE**    **23.08.19**  
Modellname    Produktionsdatum  
Model    Date of manufacture

