

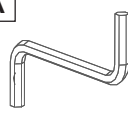

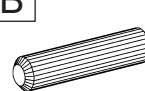

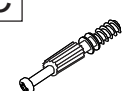



A  x1	B  x8	C  x8	D  x8
F  x1	G  x2	H  x60	I  x4
J  x4	K  x4	L  x2	



B

left - lewa

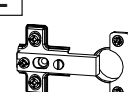
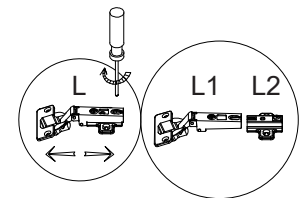
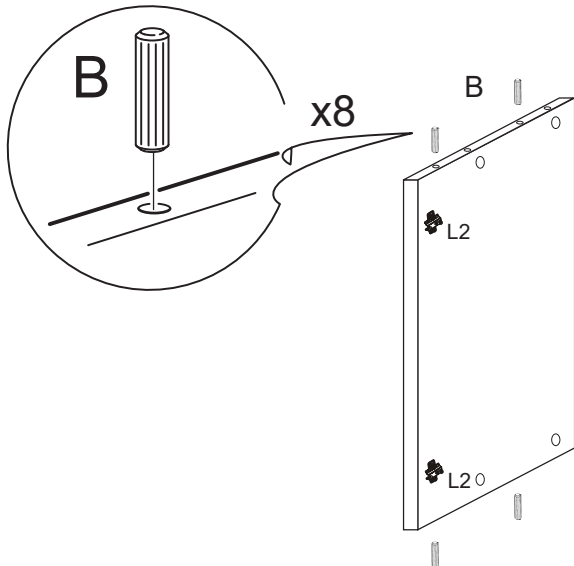
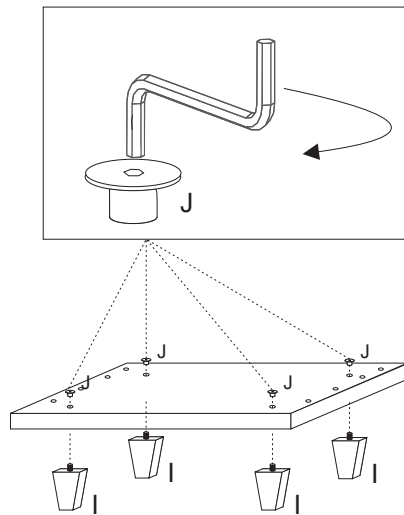
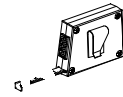
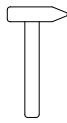
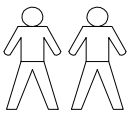
right - prawa

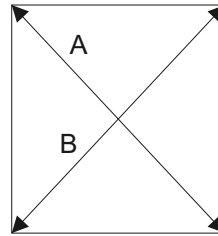
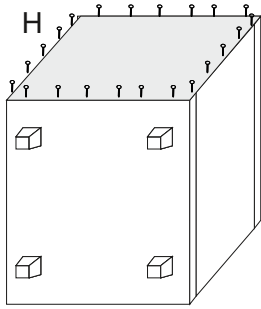
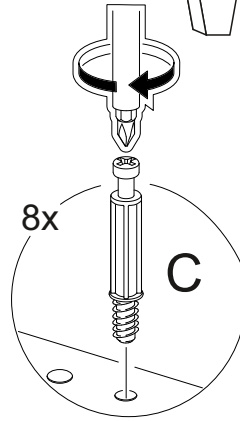
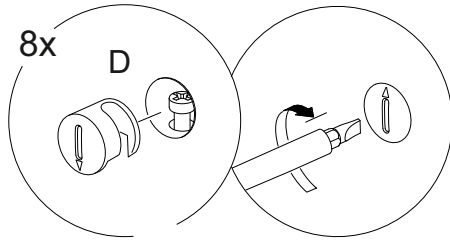
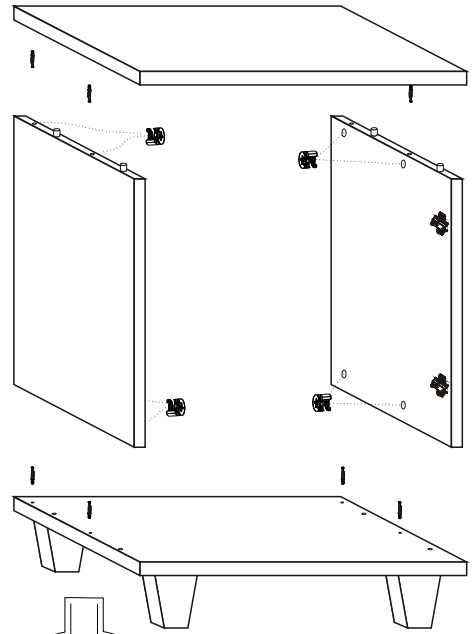
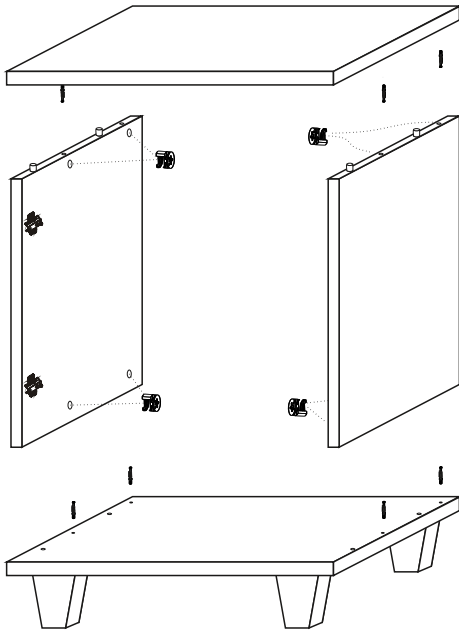

A=B

