

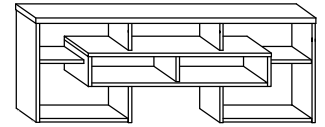

RIO-20 STOLIK RTV

→ 127 ↑ 48 ↘ 38



x 15



(a)

x 30



(b)

x 30



(c)

x 14



(d)

x 8



(e)

x 1

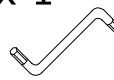

(f)

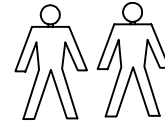
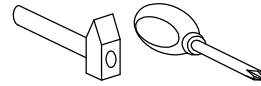

30 min



1 - FAZY MONTAŻU

A - OZNACZENIE ELEMENTÓW

a - OZNACZENIE AKCESORIÓW

1

x 7



(a)

x 14



(b)

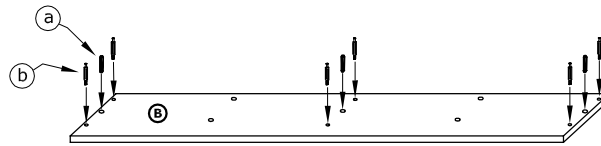
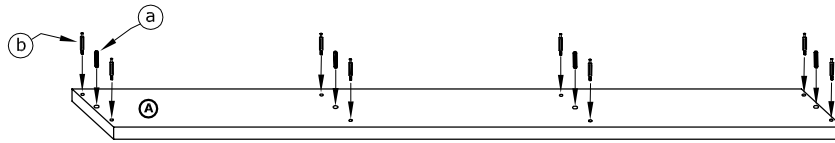

2

x 8



(a)

x 16



(b)

x 8



(e)

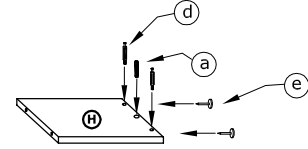
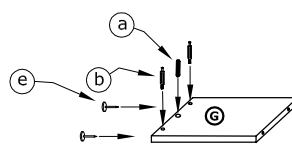
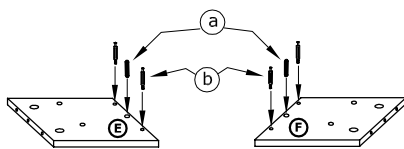
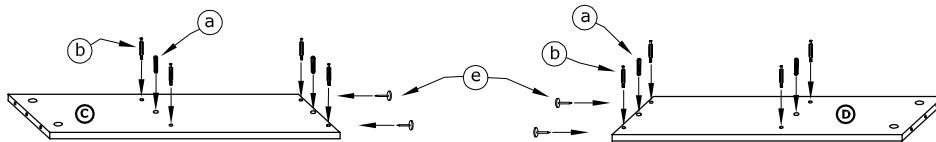

3

x 4



(c)

x 10



(d)

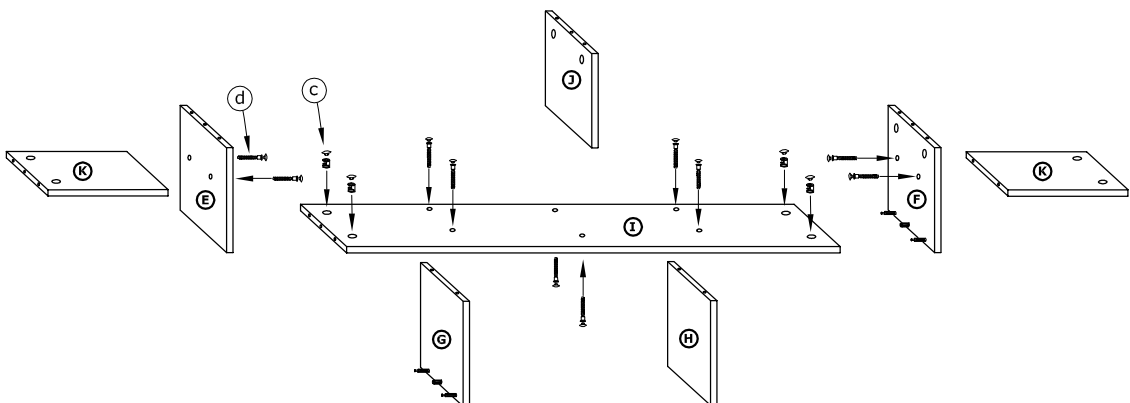

4

x 6

x 4

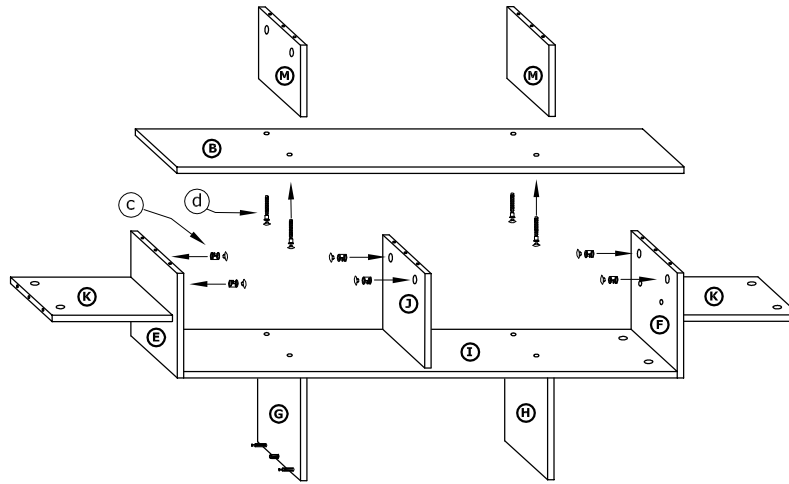
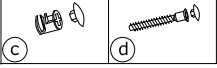

5

x 12

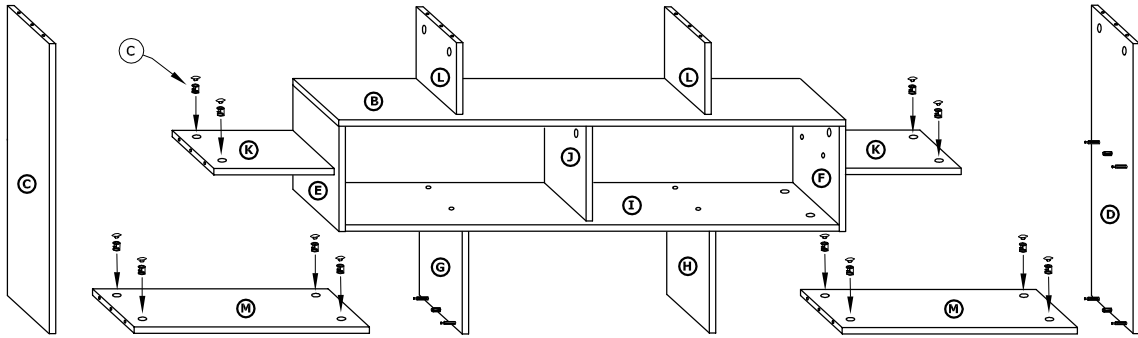
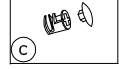

6

x 8

