

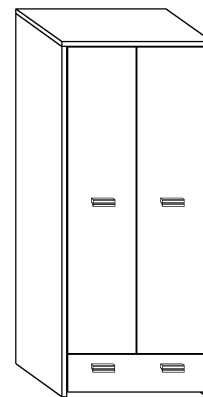









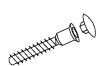
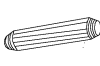

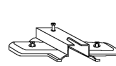
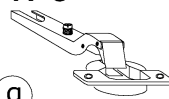
KIT-13 KITTY - SZAFKA

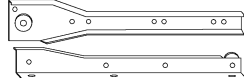
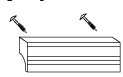
→ 80 ↑ 190 ↘ 57

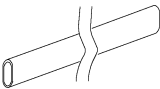

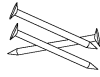
x 4 L-70  a	x 4 L-50  b	x 16  c	x 12  d	x 12  e	x 6  f
x 6  g	x 4  h	x 1 kpl. (400 mm)  i	x 4  j	x 2  k	
x 2  l	x 1 (744mm)  m	x 5 (3,5x30)  n			
x 32 (3,5x16)  o	x 95  p	x 1  r			

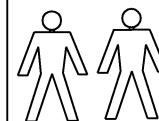

45 min



1 - FAZY MONTAŻU

A - OZNACZENIE ELEMENTÓW

a - OZNACZENIE AKCESORIÓW

1

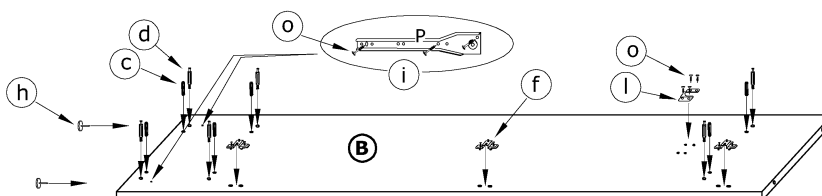
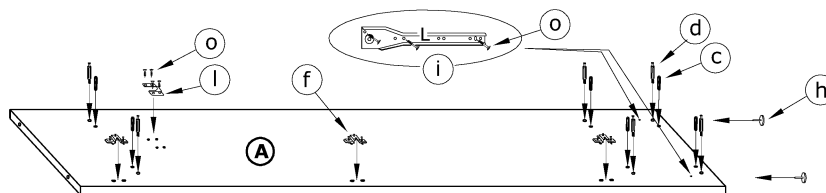

2

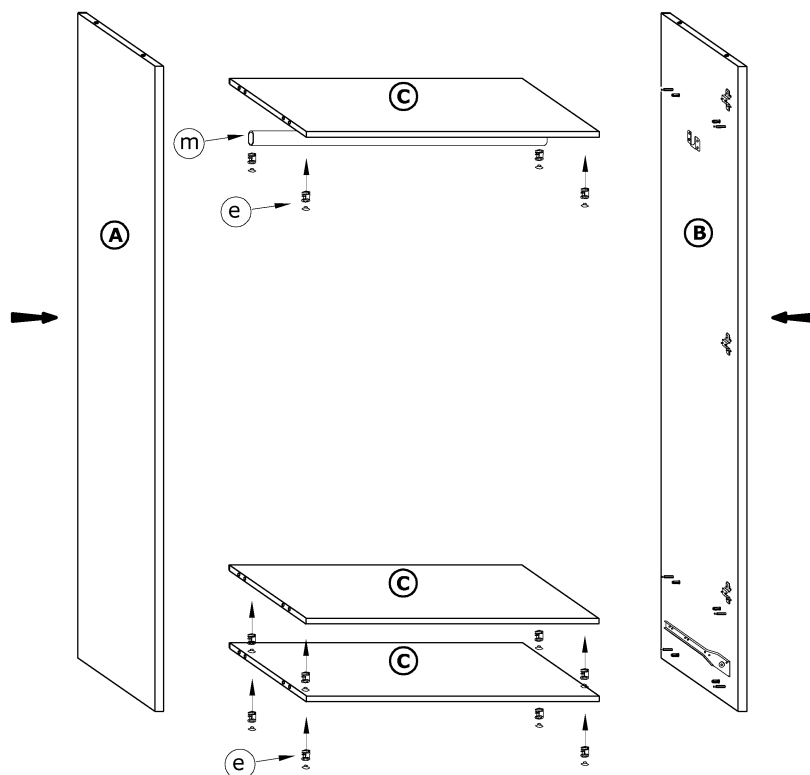

3

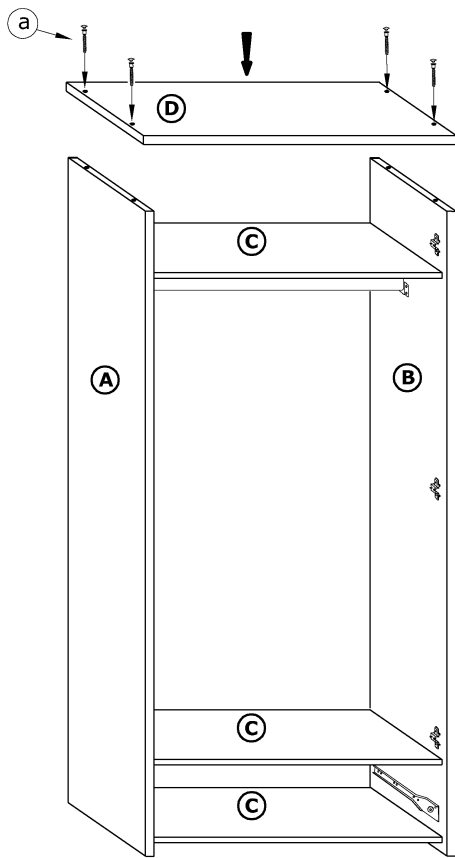

4

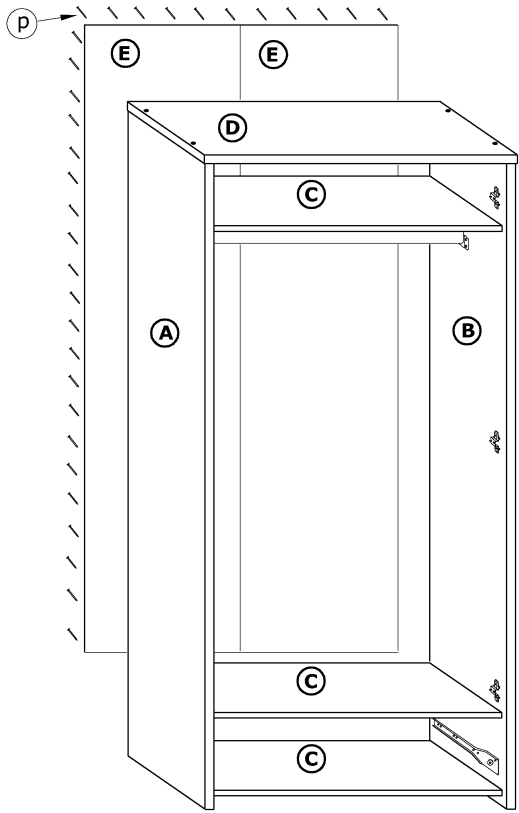

5

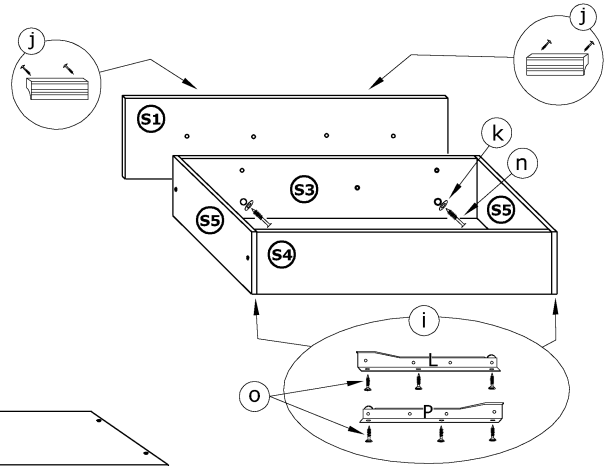
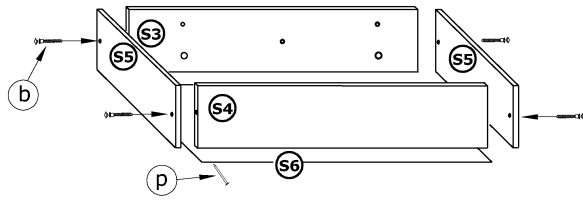

6

