

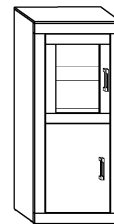

VRN-16 VERIN - REGAŁ 1DW

► 60 ▲ 141 ▼ 34



x 22



(a)

x 2



(b)

x 24



(c)

x 16



(d)

x 4



(e)

x 4



(f)

x 2

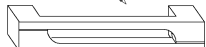

(g)

x 4

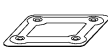

(h)

x 8



(i)

x 4



(j)

x 24 (3,5x16)



(k)

x 50



(l)

40 min

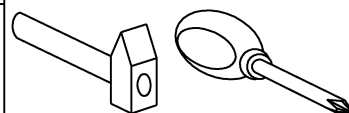
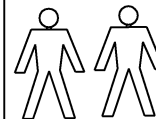

1 - FAZY MONTAŻU

A - OZNACZENIE ELEMENTÓW

a - OZNACZENIE AKCESORIÓW

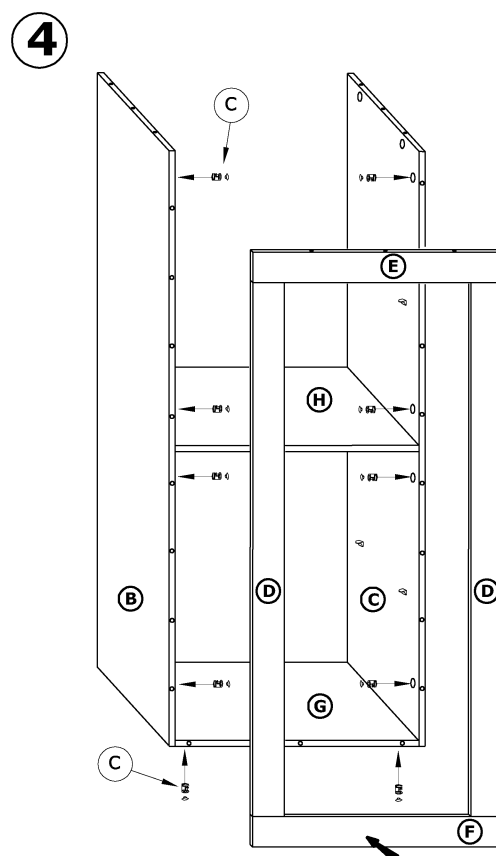
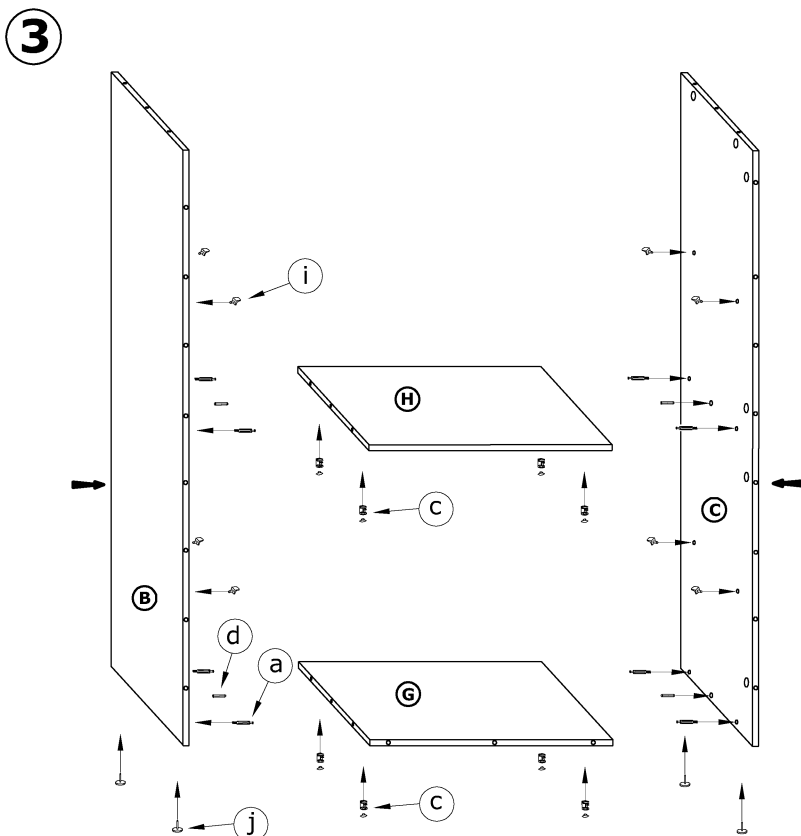
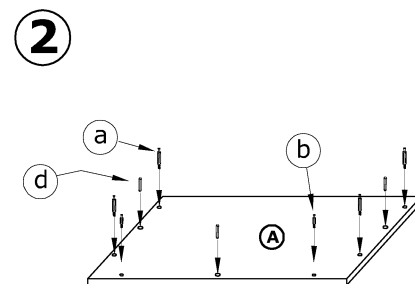
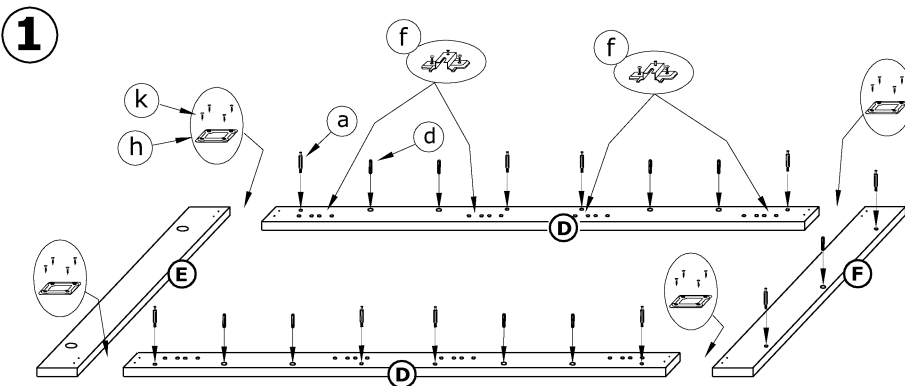

5

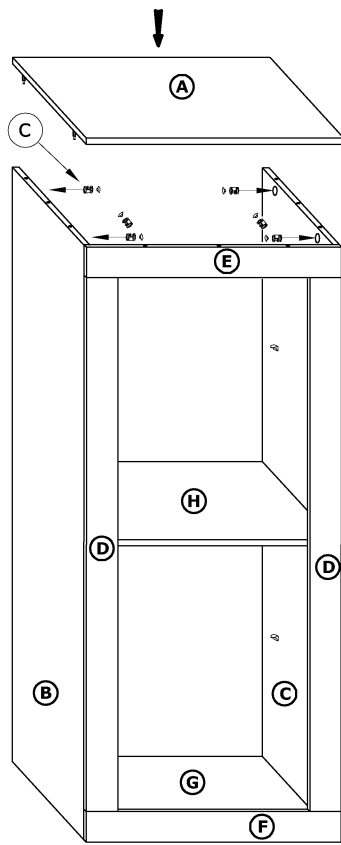

6

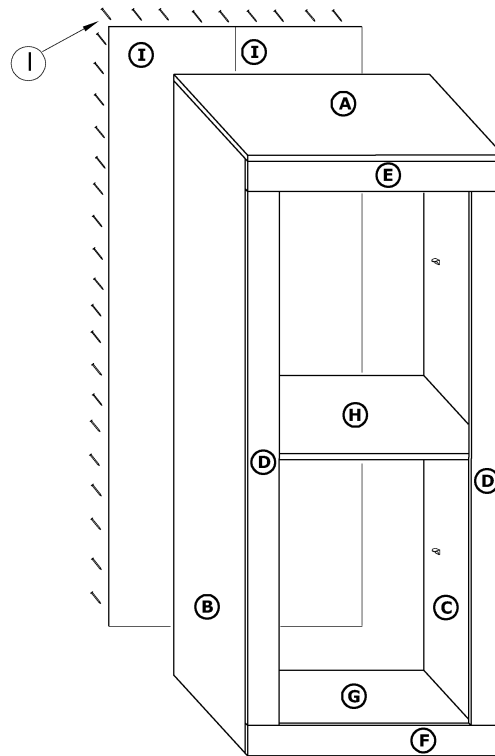

7

