

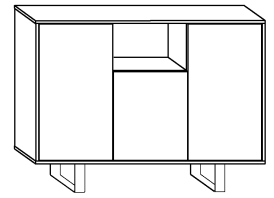

# KING 4

→120↑90↘36



x 4  a	x 12  b	x 8  c	x 8  d	x 2  e	x 4  f		
x 6  g	x 12  h	x 3  j	x 3  k	x 38 (3,5x16)  l	x 60  m		x 1  n
x 2  i				 o	 p		 40 min

① - FAZY MONTAŻU

Ⓐ - OZNACZENIE ELEMENTÓW

Ⓐ - OZNACZENIE AKCESORIÓW

**1**

x 4  a	x 8  c
x 2  j	x 8 (3,5x16)  l

**2**

x 4  g
x 4  h

**3**

x 2  g	x 2  h
x 1  j	x 4 (3,5x16)  l

**4**

x 4  b
x 6  h

5

x 8



x 8

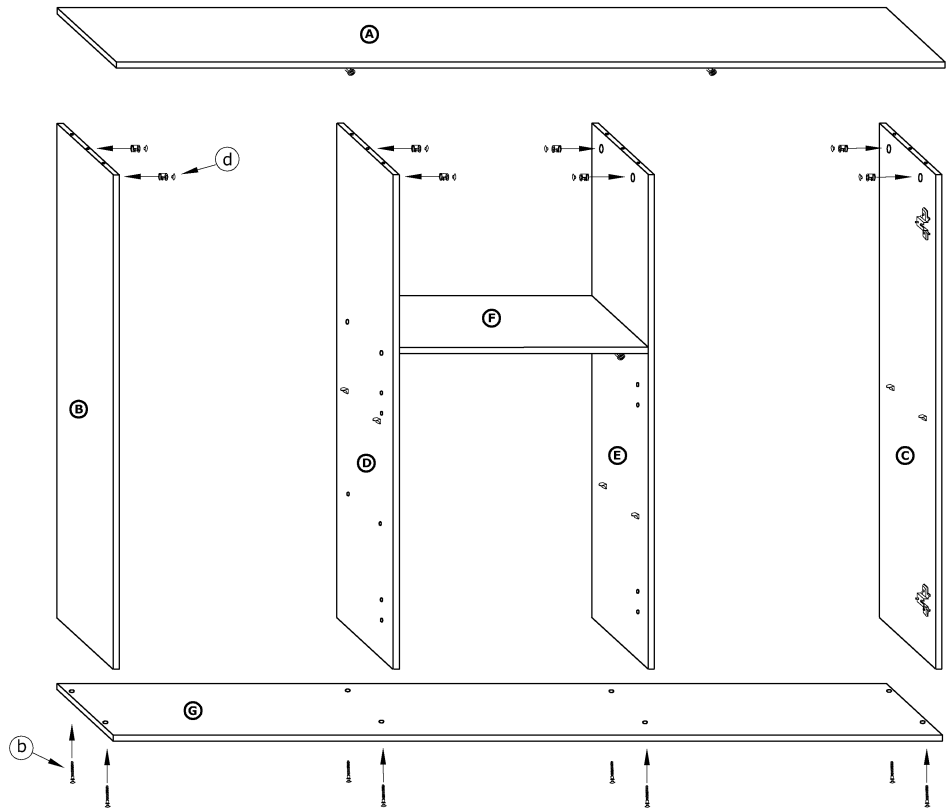

6

x 2



x 8



(3,5x16)

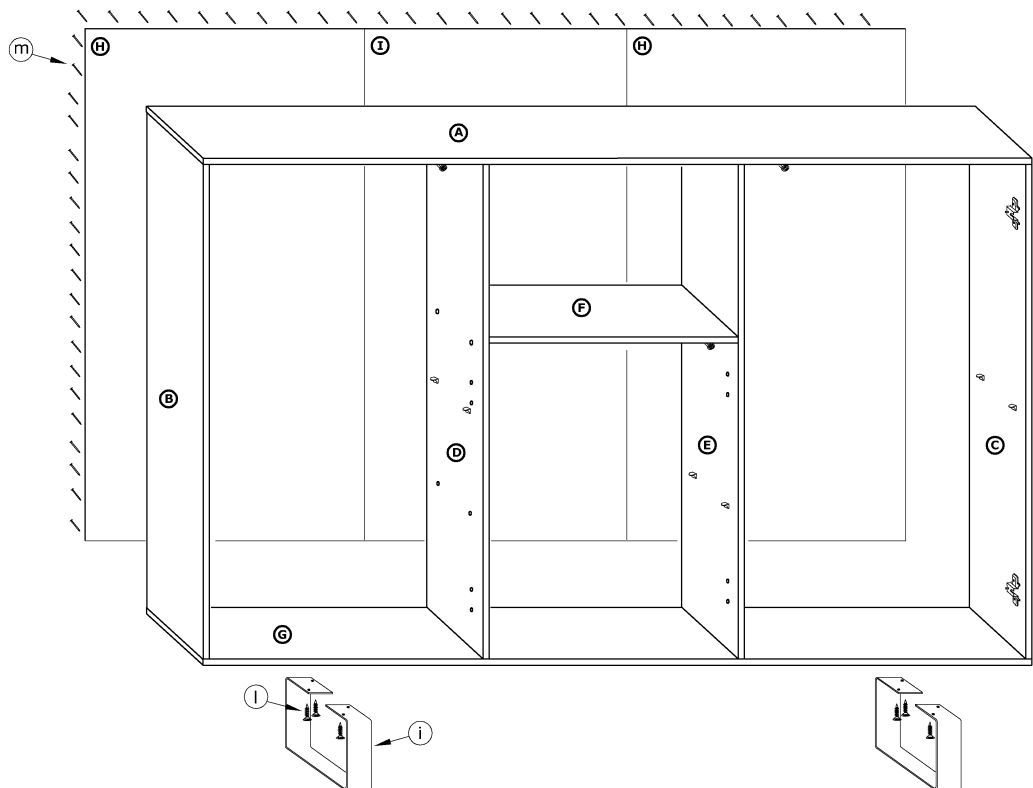

x 60



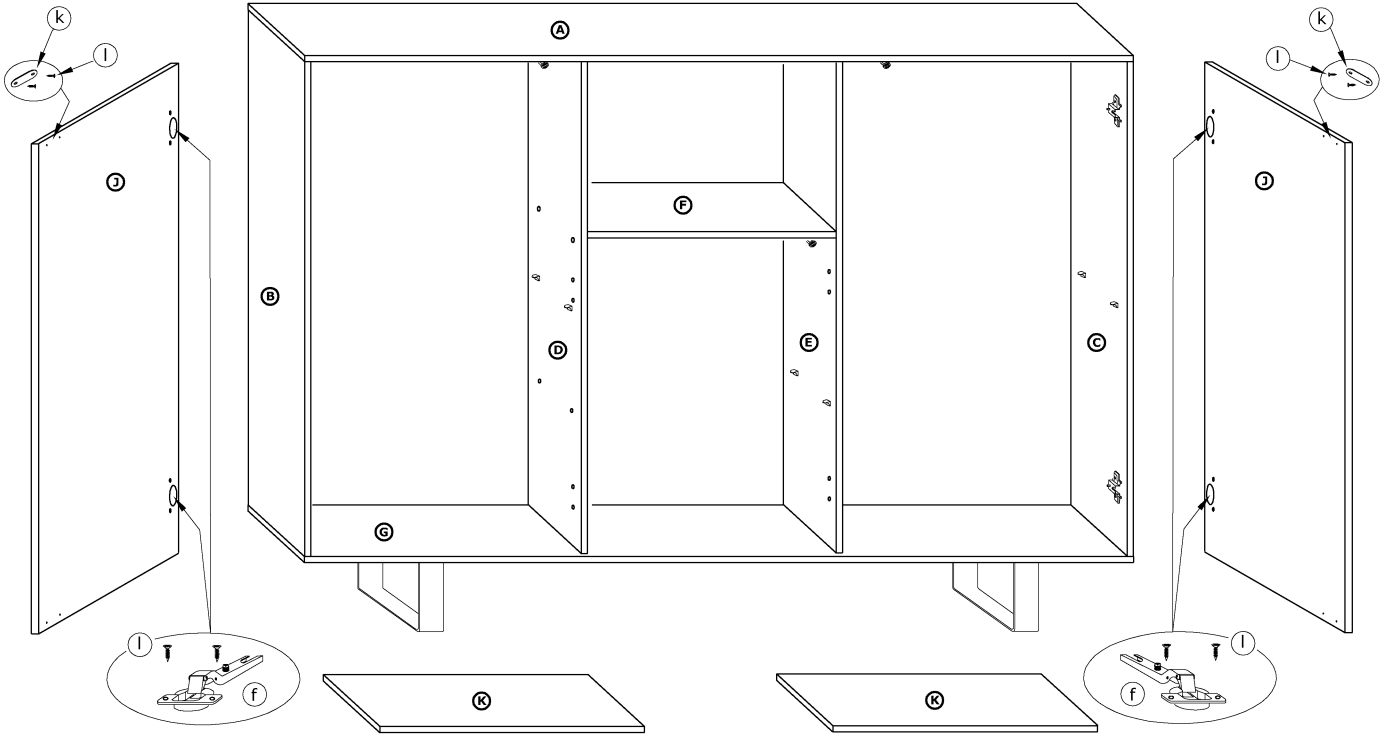

7

- x 4  f
- x 2  k
- x 12 (3,5x16)  l



8

- x 2  e
- x 1  k
- x 6 (3,5x16)  l

