

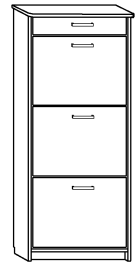

ATHENA 3/60

- 59 +141-20



x 24 a	x 10 b	x 10 c	x 8 d	x 8 e	x 3 f		
x 2 g	x 5 h	x 4 j	x 2 k	x 44 (3,5x16) l	x 18 (6,2x16) m	x 2 n	x 60 o
x 3 kpl. i		x 1 (1314 mm) p		 40 min			

1 - FAZY MONTAŻU

A - OZNACZENIE ELEMENTÓW

a - OZNACZENIE AKCESORIÓW

1

x 4
a

x 2
b

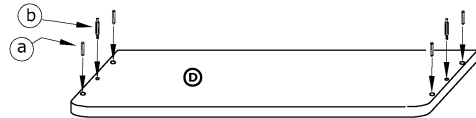

2

x 18
a

x 8
b

x 2
g

x 4
h

x 2
k

x 2 (3,5x16)
l

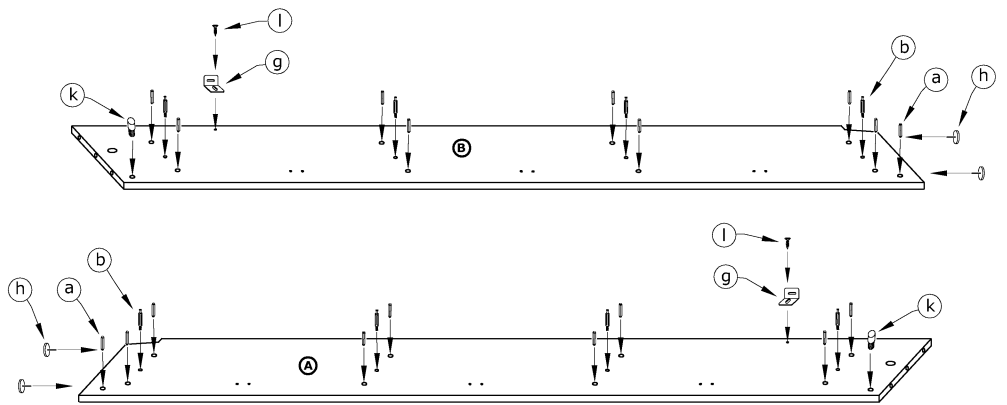

3

x 2
a

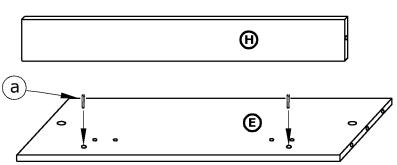

4

x 8
e

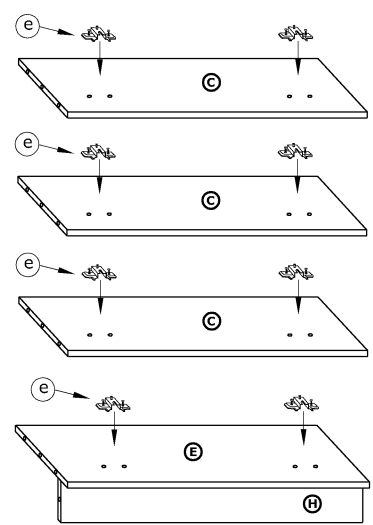

5

x 8

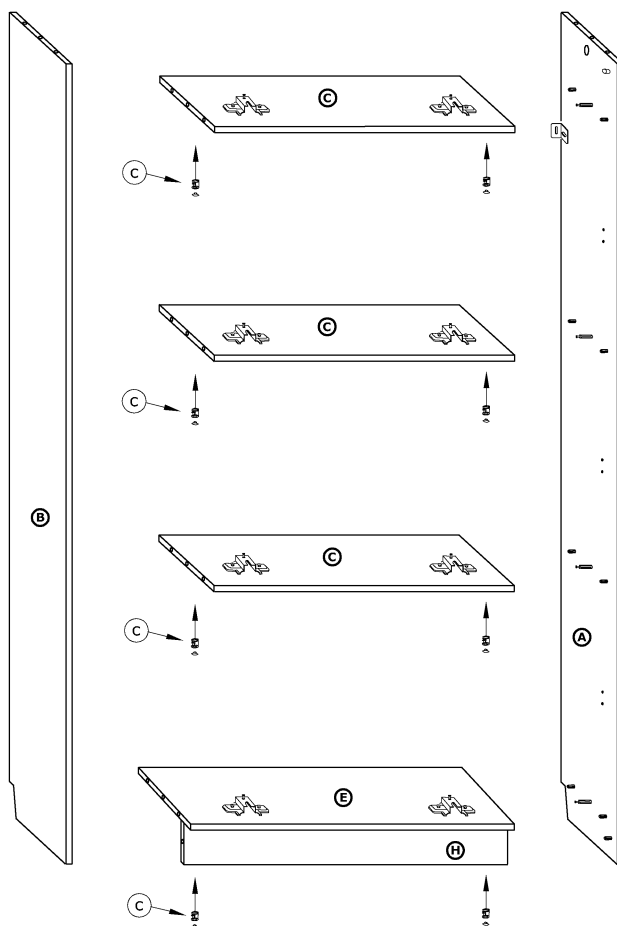
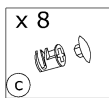

6

x 2

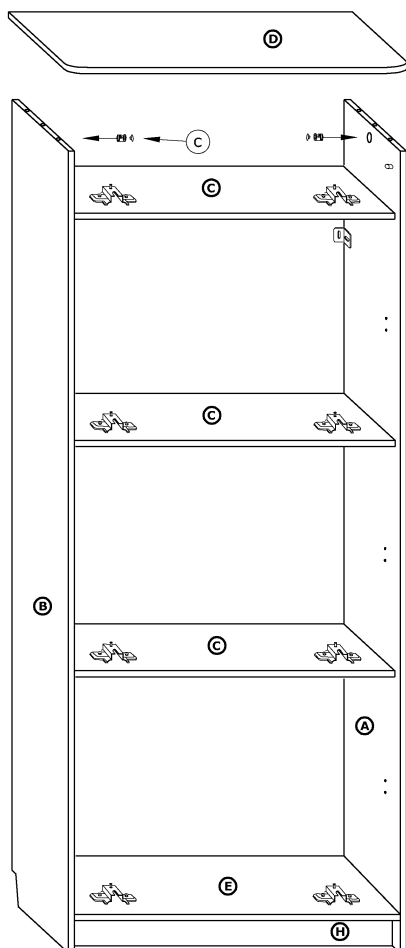
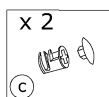



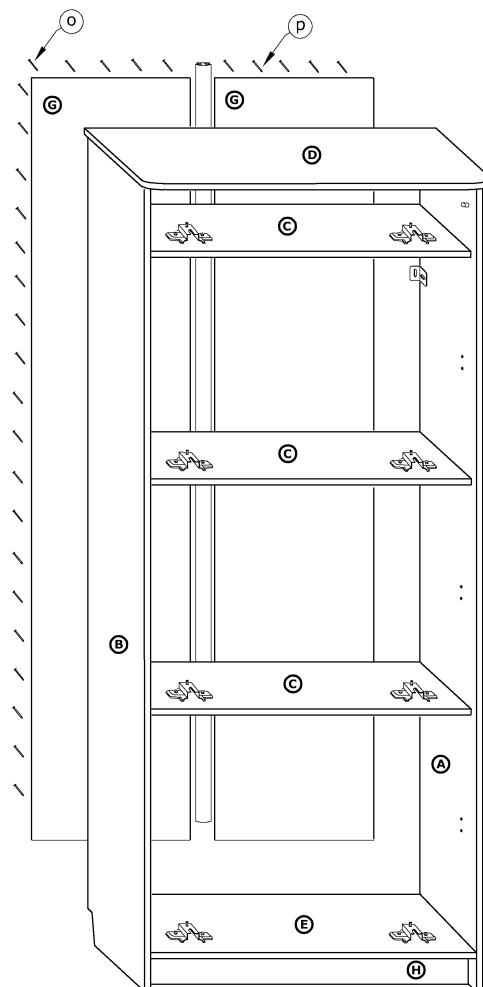
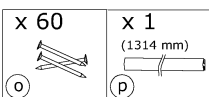

7

x 60

x 1
(1314 mm)





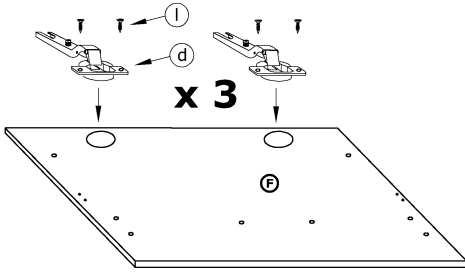

8

- x 6  
- x 12 (3,5x16)  





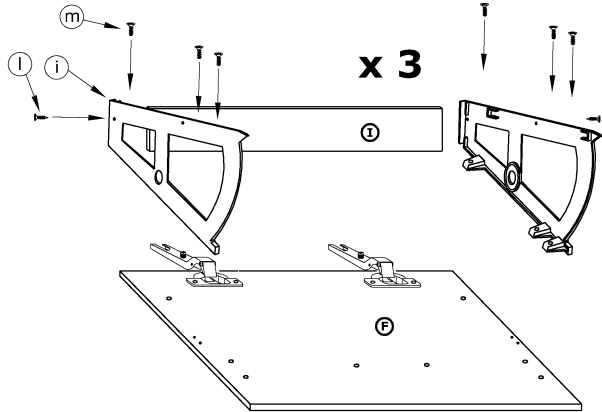

9

- x 6 (3,5x16) 
- x 18 (6,2x16) 
- x 3 kpl.  



10

- x 2  
- x 4 (3,5x16)  

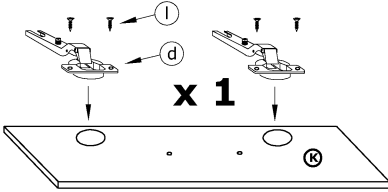

11

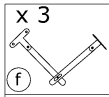
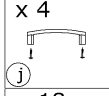
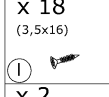
- x 3 
- x 4 
- x 18 (3,5x16) 
- x 2 