

x 10 		x 22 		x 4 	x 4 
x 3 	x 4 	x 4 		x 2 	
x 6 	x 2 	x 1 (300 mm - kpl.) 		x 1 	
x 4 	x 4 (3,5x30) 	x 32 (3,5x16) 	x 40 	x 1 	



**1** - FAZY MONTAŻU

**A** - OZNACZENIE ELEMENTÓW

**a** - OZNACZENIE AKCESORIÓW

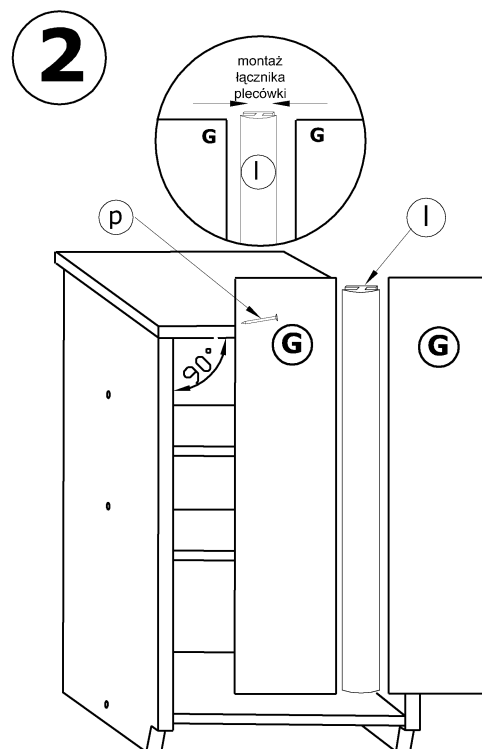
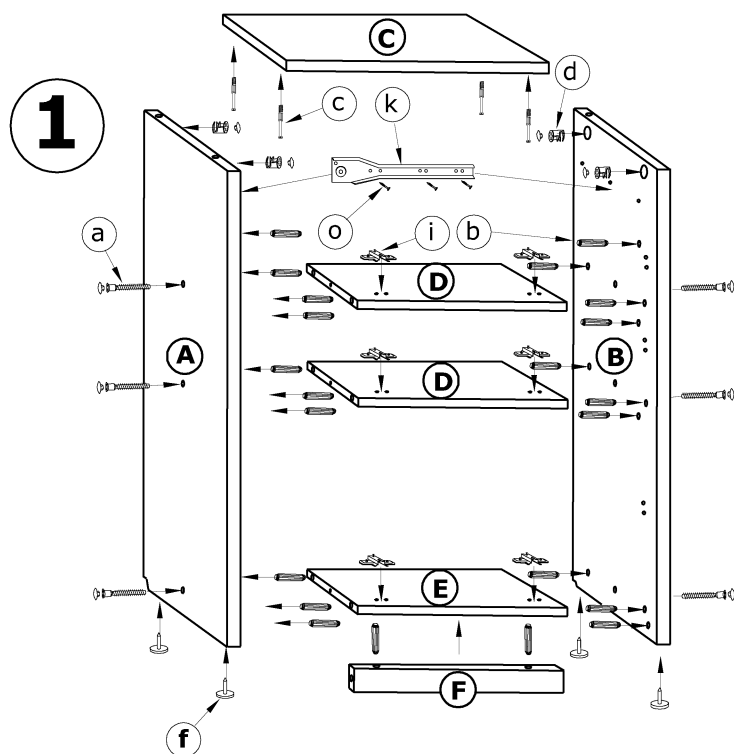

3

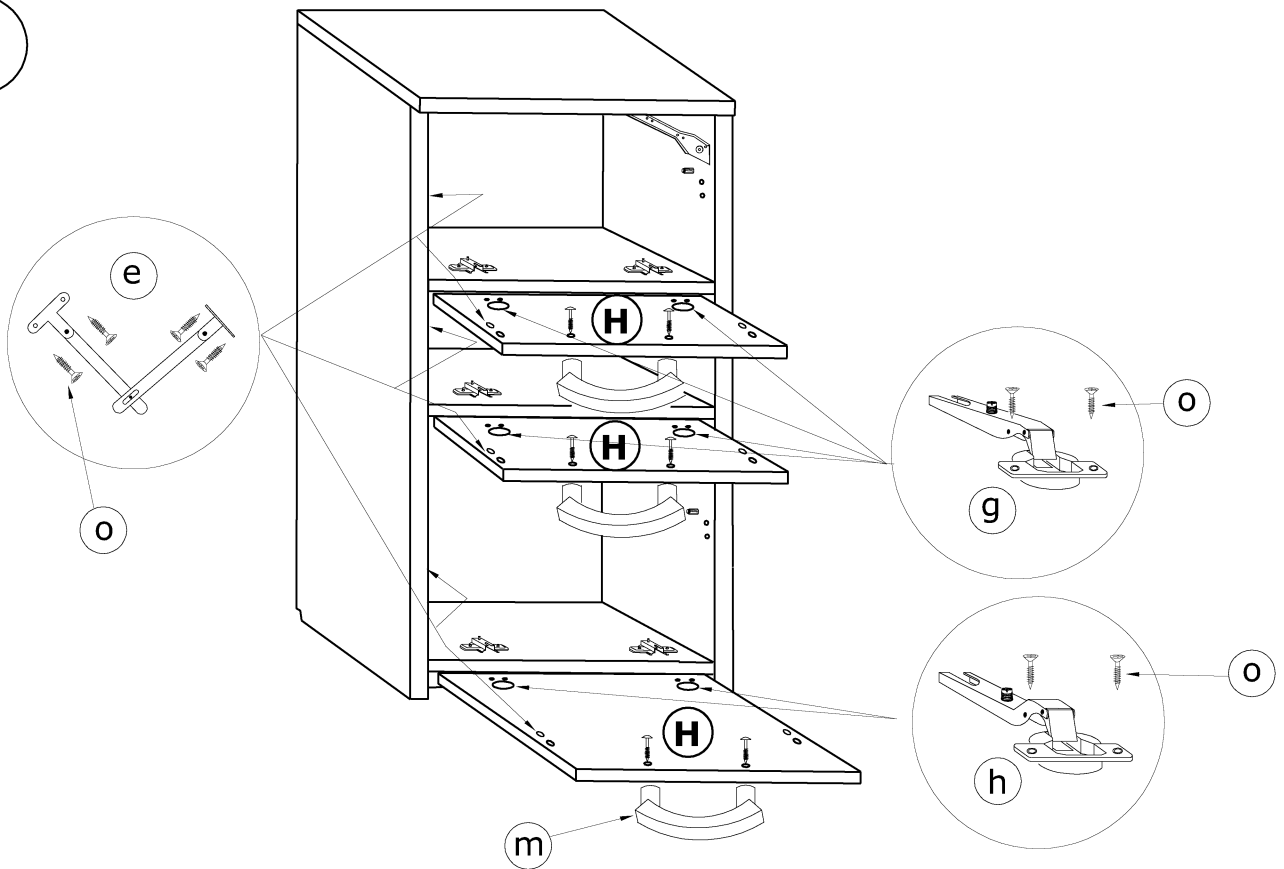

4

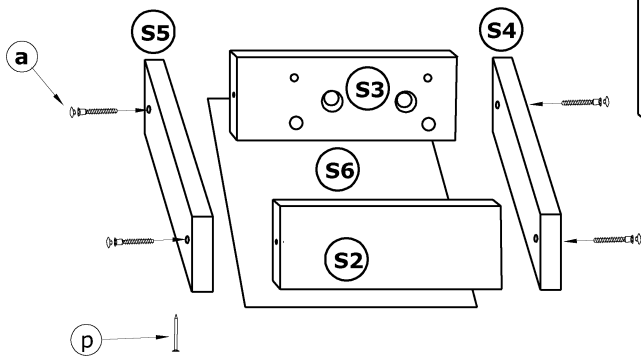

5

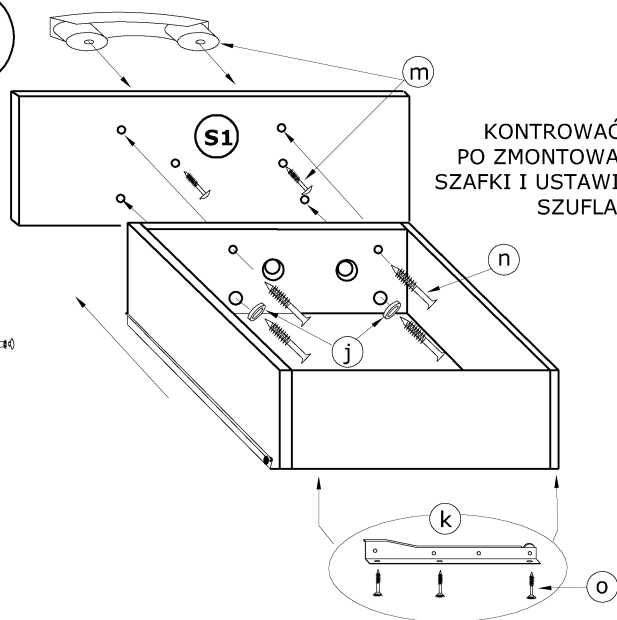

KONTROWAĆ FRONT  
PO ZMONTOWANIU CAŁEJ  
SZAFKI I USTAWIENIU CZOŁA  
SZUFLADY