

KING 7

→ 60 ↑ 165 ↘ 36

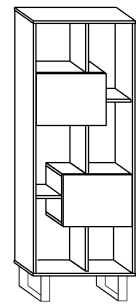

x 26



(a)

x 12

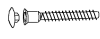

(b)

x 24

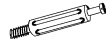

(c)

x 24



(d)

x 4

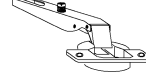

(e)

x 4

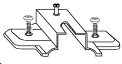

(f)

x 2

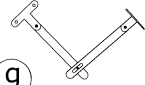

(g)

x 2

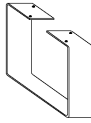

(h)

x 2



(i)

x 2



(j)

x 36

(3,5x16)



(k)

x 60

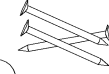

(l)

x 1

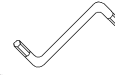

(m)

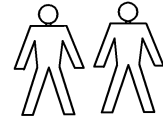

40 min

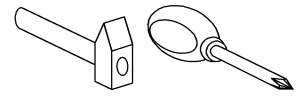
**1** - FAZY MONTAŻU**A** - OZNACZENIE ELEMENTÓW**a** - OZNACZENIE AKCESORIÓW**1**

x 4



(a)

x 5

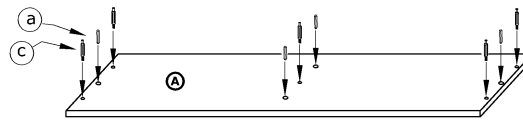

(c)

**2**

x 8



(a)

x 10

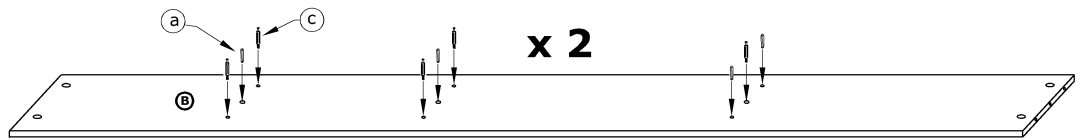

(c)

**3**

x 4



(f)

x 2



(i)

x 8

(3,5x16)

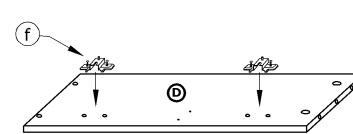
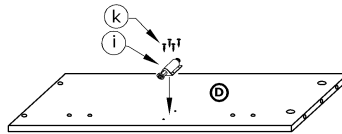
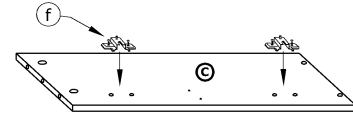
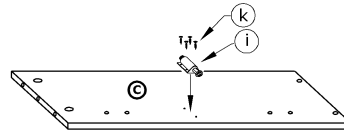

(k)

**4**

x 8



(a)

x 8



(b)

x 4



(c)

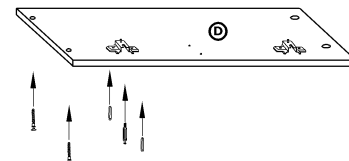
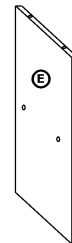
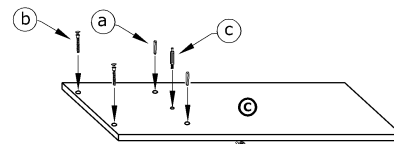
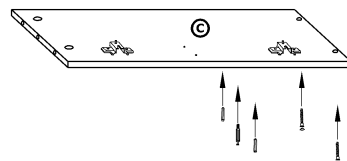
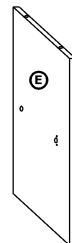
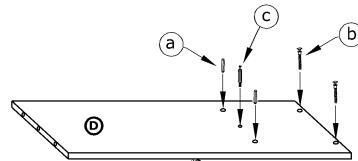

- 5** x 6
 (b) x 6
 (d)

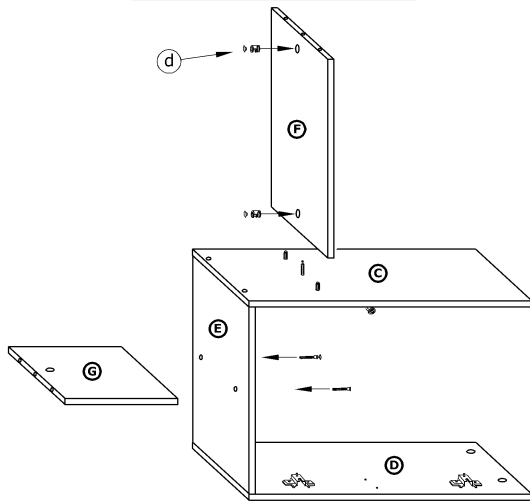
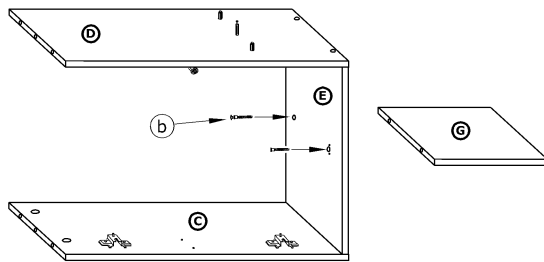

- 7** x 6 x 5
 (b) (d)

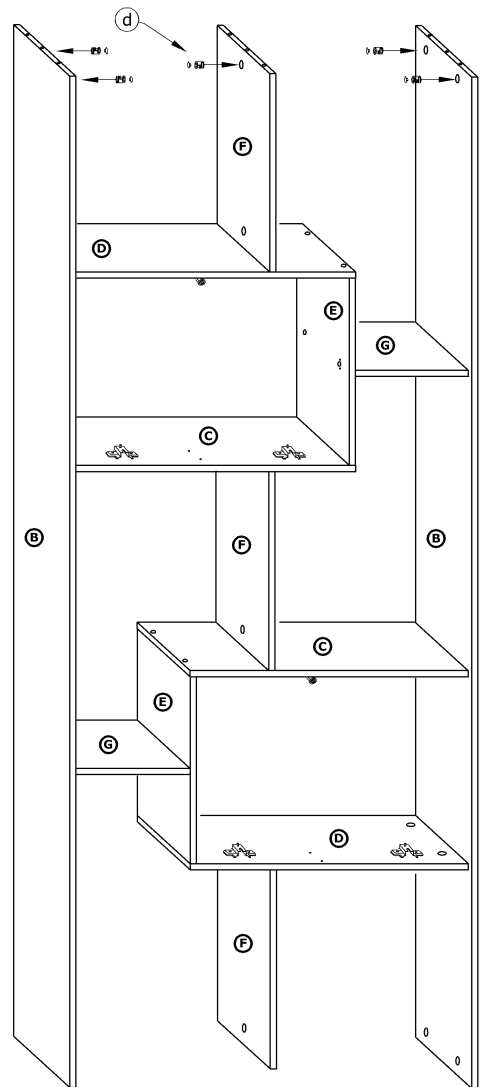
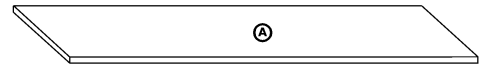

- 6** x 12
 (d)

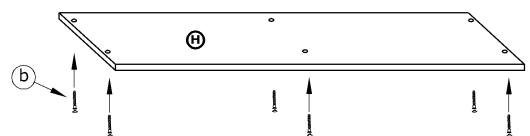
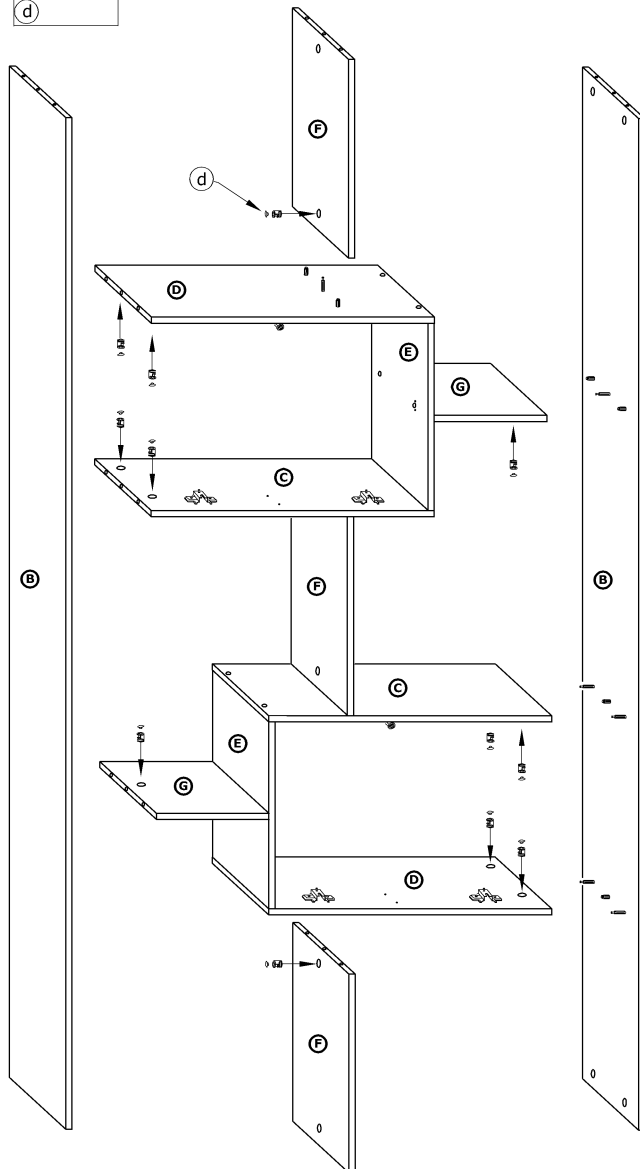

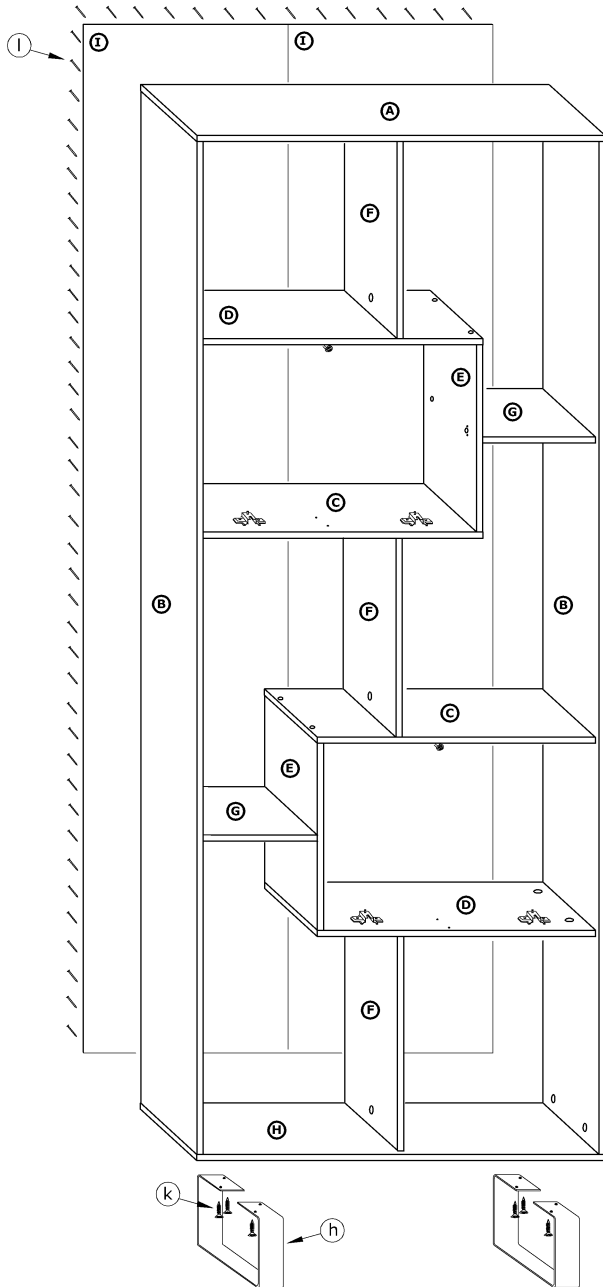
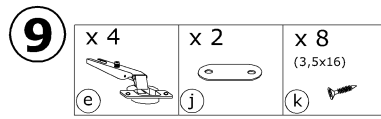
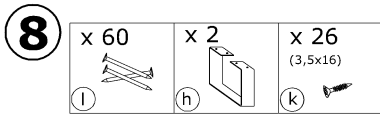

x 2

