

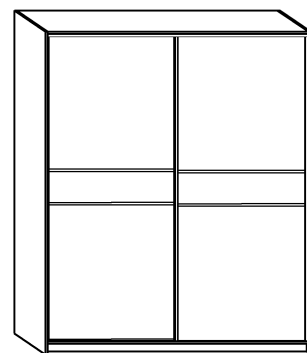











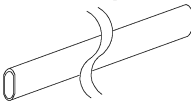



# PUERTO 200B

→ 200 ↑ 216 ↘ 65



x 28  <b>(a)</b>	x 15  <b>(b)</b>	x 2  <b>(c)</b>	x 2  <b>(d)</b>
x 2 (1174 mm)  <b>(e)</b>	x 4  <b>(f)</b>	x 6  <b>(g)</b>	x 2  <b>(h)</b>
x 4  <b>(j)</b>	x 4  <b>(k)</b>	x 4  <b>(l)</b>	 <b>(i)</b>
x 40 (3,5 x 13)  <b>(m)</b>	x 8 (6,2 x 13)  <b>(n)</b>	x 150  <b>(o)</b>	x 1  <b>(p)</b>

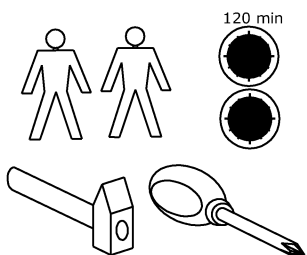

**1** - FAZY MONTAŻU

**A** - OZNACZENIE ELEMENTÓW

**a** - OZNACZENIE AKCESORIÓW

**1**

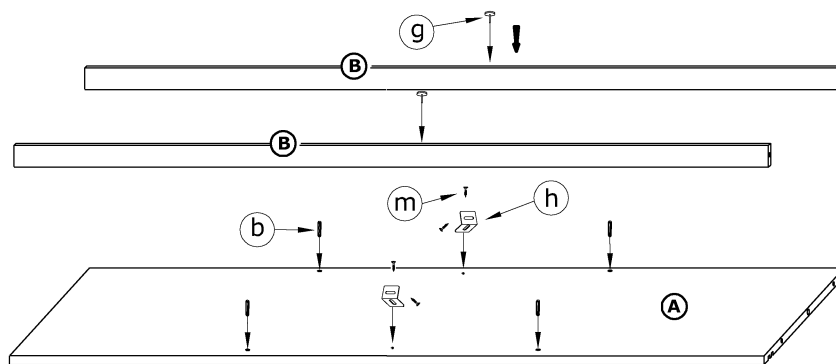

**2**

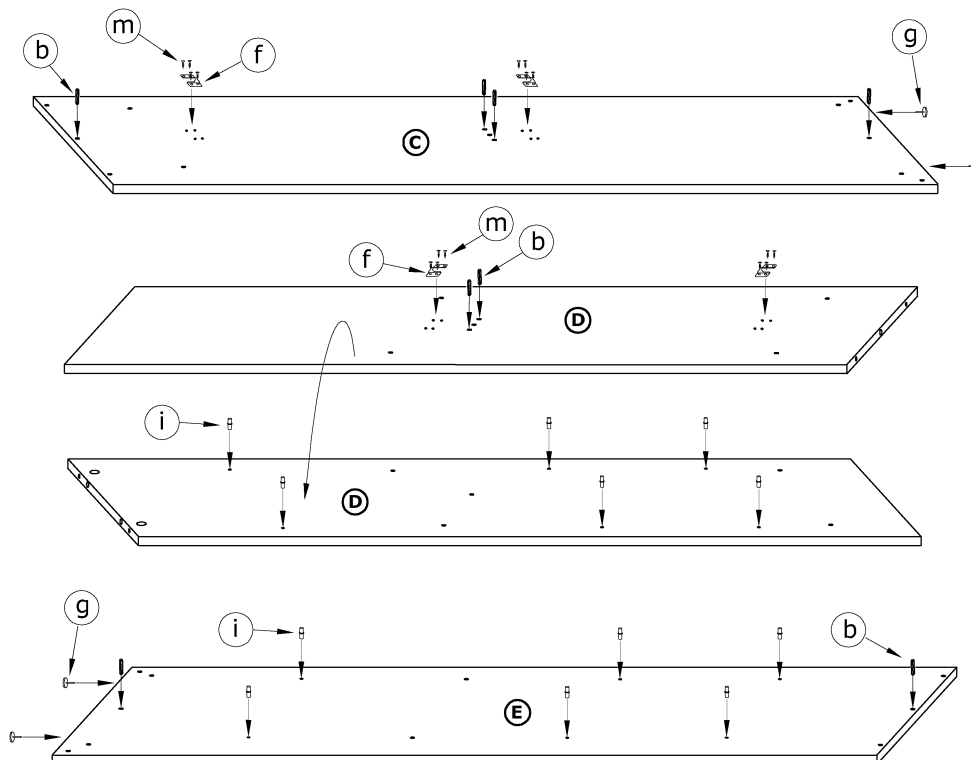

3

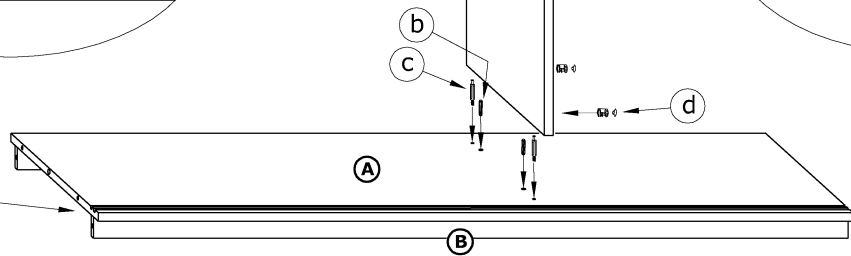
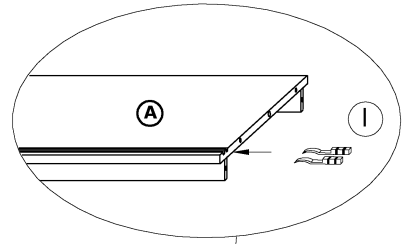
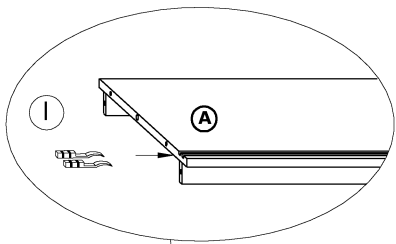
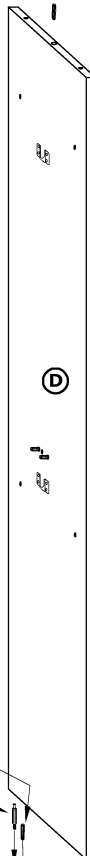
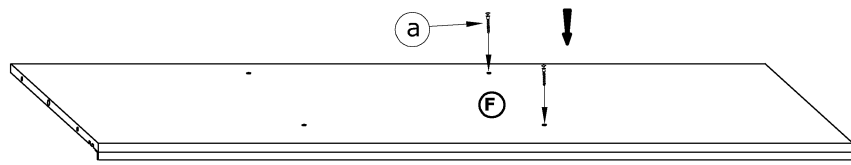

4

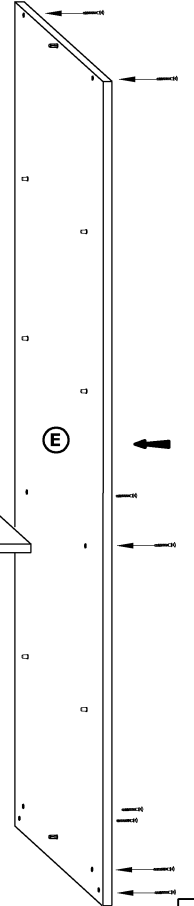
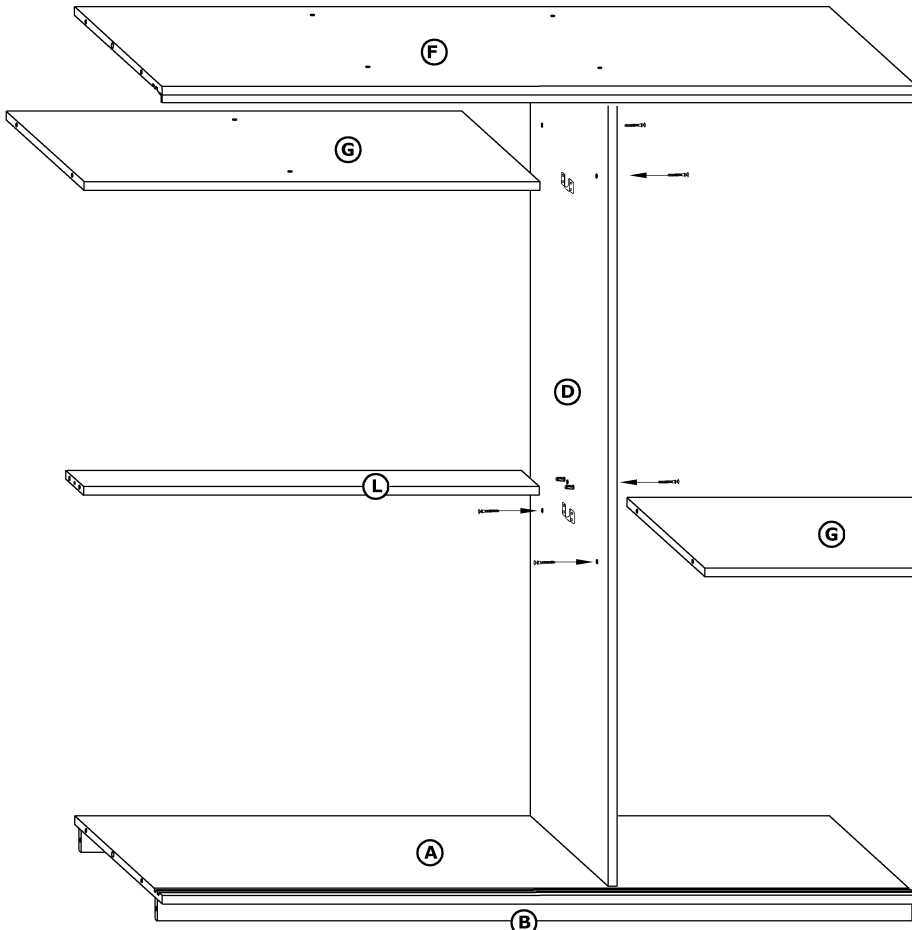
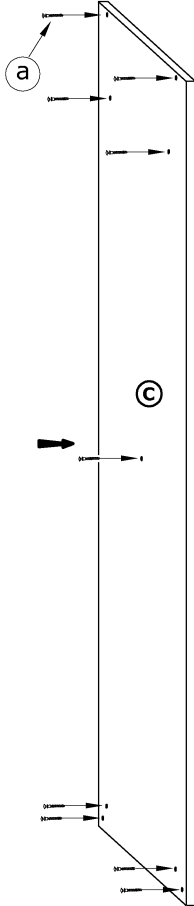

5

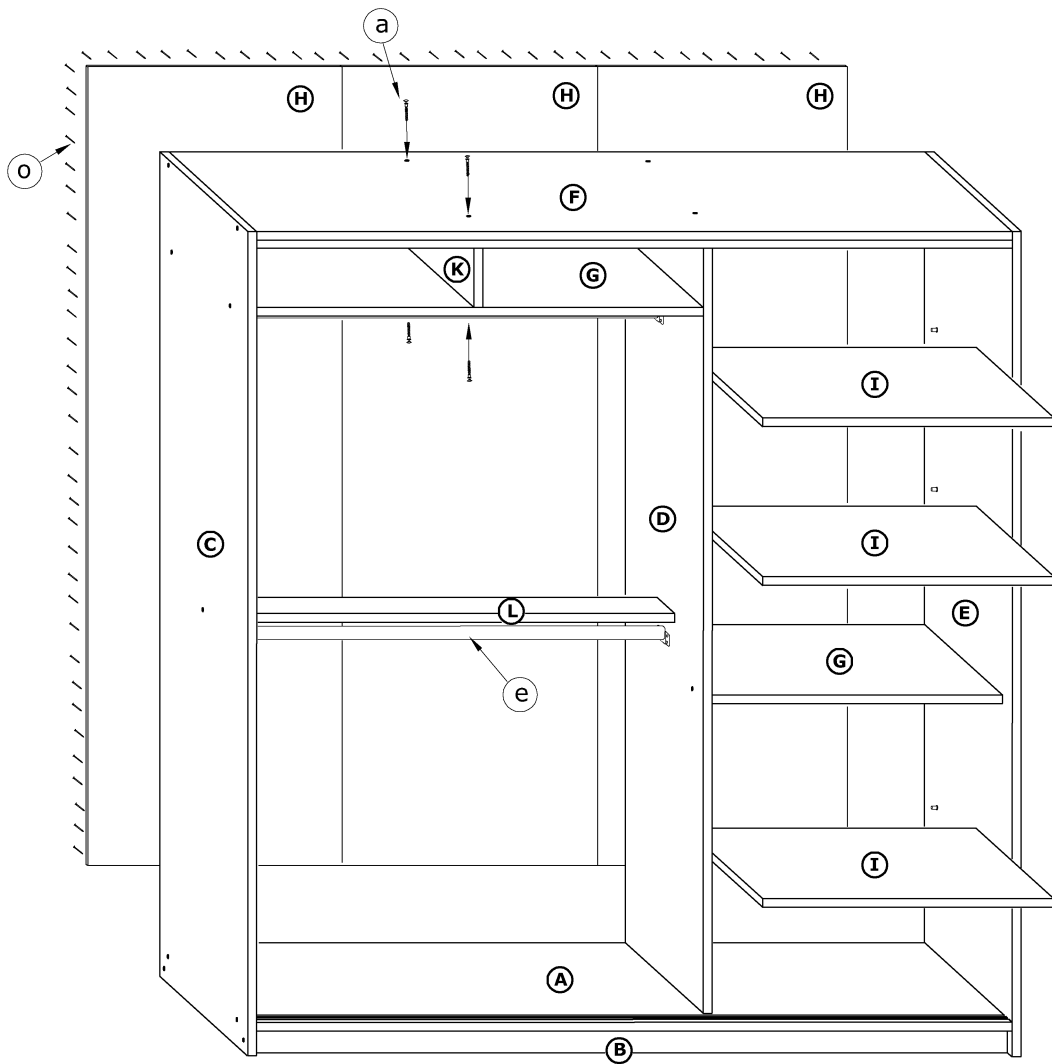

6

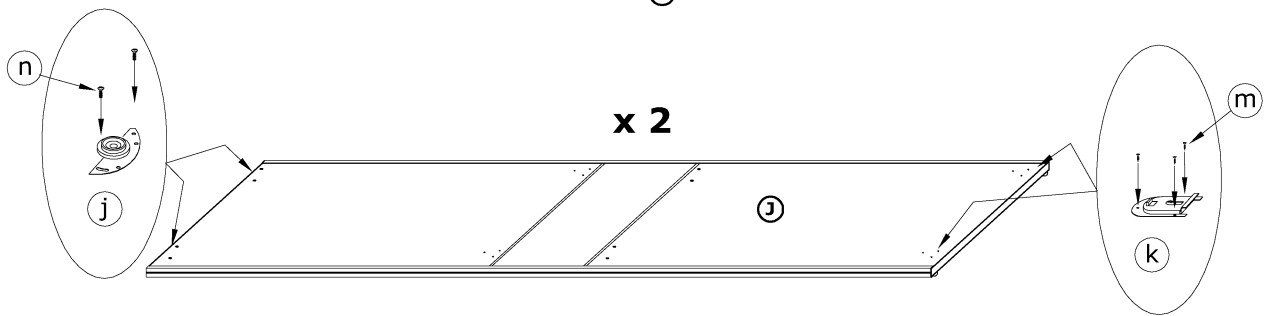

7

