

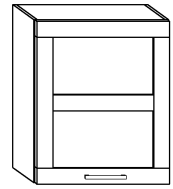

POLO - W60PN

→60 ↑ 72 ↘34



x 8

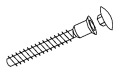

x 2

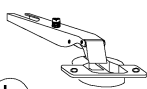

x 2

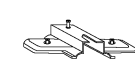

x 1



(a)

(b)

(c)

(d)

x 4



x 2



x 4 (4x16)



x 4 (3,5x30)



(e)

(f)

(g)

(h)

x 15



x 1



x 1

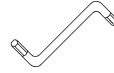

(i)

(j)

(k)

25 min

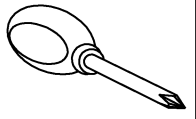
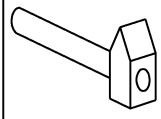
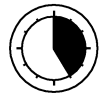
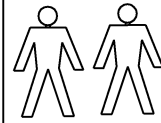

1 - FAZY MONTAŻU

A - OZNACZENIE ELEMENTÓW

a - OZNACZENIE AKCESORIÓW

1

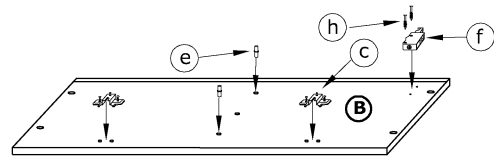
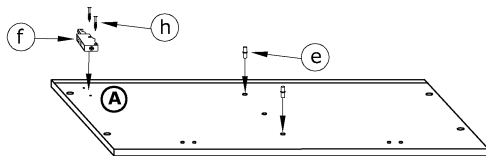

2

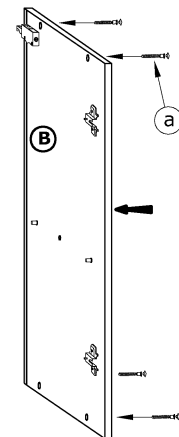
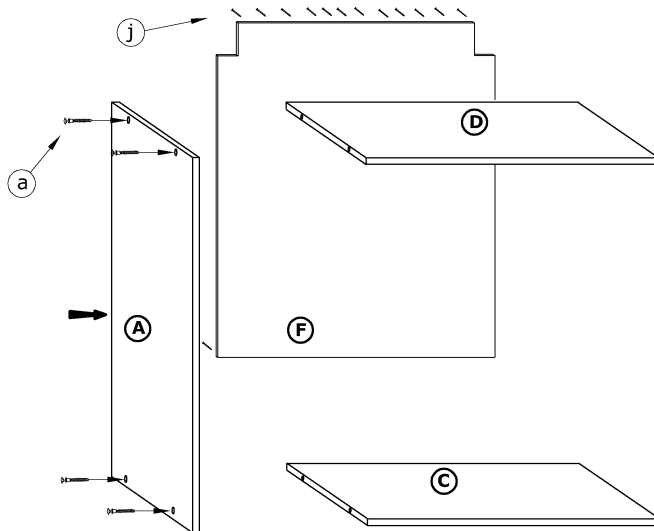

3

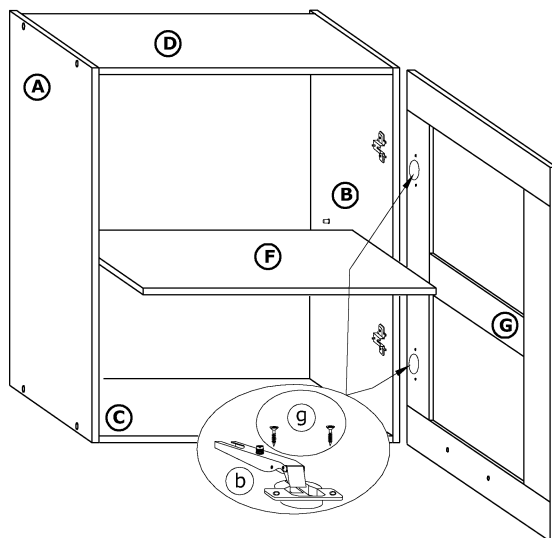

4

