

SAV
SPAREPARTS
KUNDERDIENST
POS VENTAS
SERVICE NA VERKOOP
SERVIZIO POST-VENDITA
SERVICO DEPOIS DE VENDA
SERWIS POGWARANCY JNY

8620-00 PING

(FR) SECURITE

RESPECTER LES INTRUCTIONS DE MONTAGE DECRITES DANS LA NOTICE

(EN) CAUTION

FOLLOW CAREFULLY THE ASSEMBLING INSTRUCTIONS DESCRIBED IN THE DIRECTIONS

(DE) SICHERHEITSVORSCHRIFTEN

BEACHTEN SIE BITTE UNBEDINGT DIE ANGEGEBENEN AUFBAUVORSCHRIFTEN

(ES) SEGURIDAD

RESPECTAR LAS INSTRUCCIONES DE MONTAJE DESCRIBIDAS EN EL FOLLETO

(NL) VEILIGHEID

GELIEVE DE MONTAGEINSTRUCTIES ZOALS BESCHREVEN IN DE HANDLEIDING TE RESPECTEREN

(IT) SICUREZZA

RISPETTARE LE ISTRUZIONI DI MONTAGGIO DESCRITTE NELLA AVVERTENZA

(PT) SEGURANCA

RESPEITAR LE INSTRUCOES DE MONTAGEM DESCRIVIDAS NA INSTRUÇÃO DE USO

(PL) UWAGA

PROSZĘ PRZESTRZEGAĆ INSTRUCJI MONTAŻU

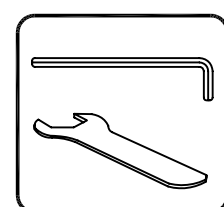
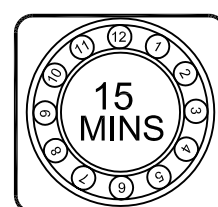
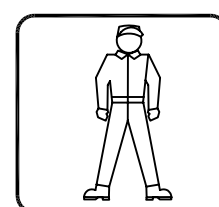
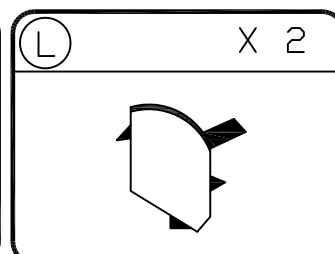
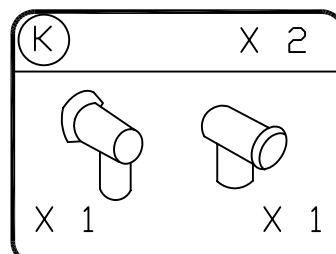
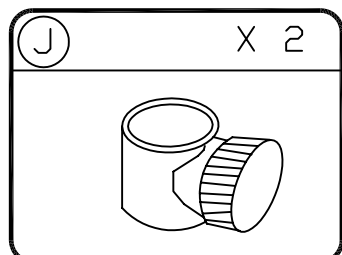
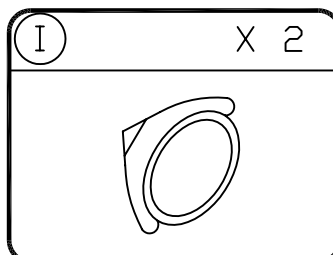
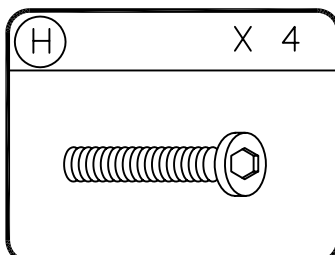
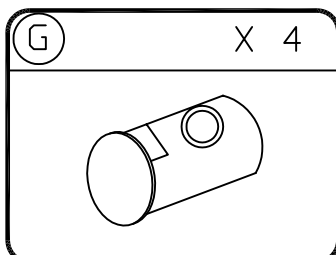
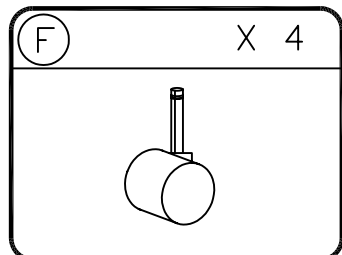
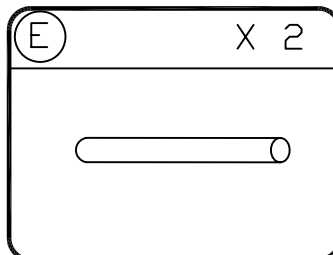
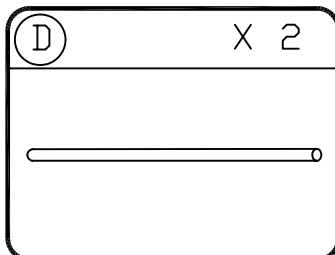
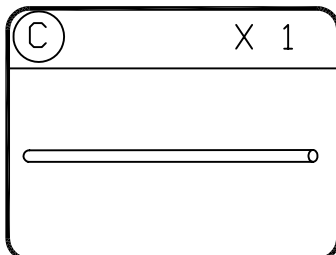
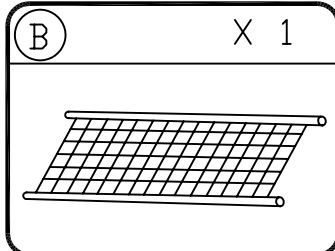
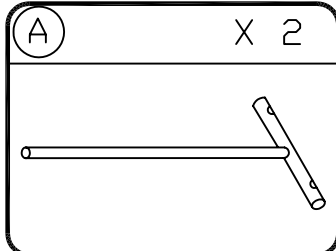
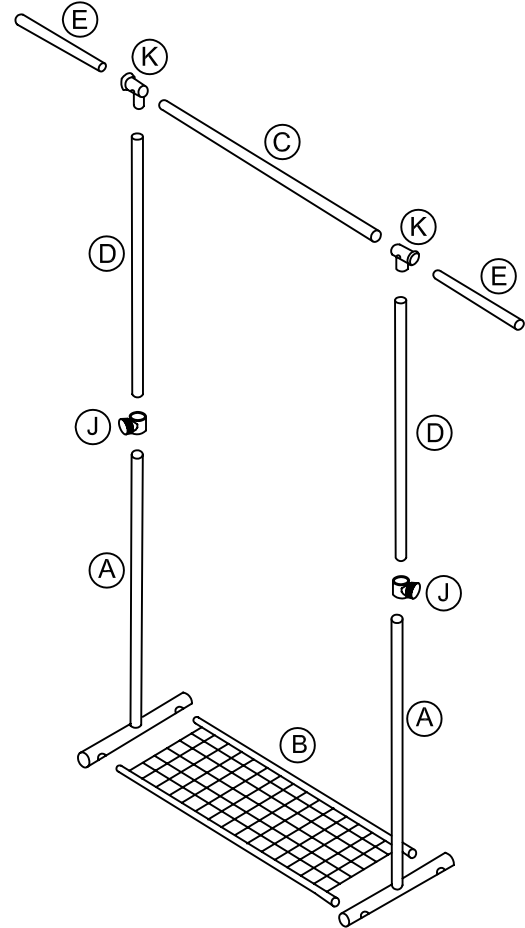

1

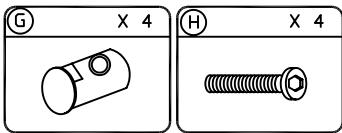
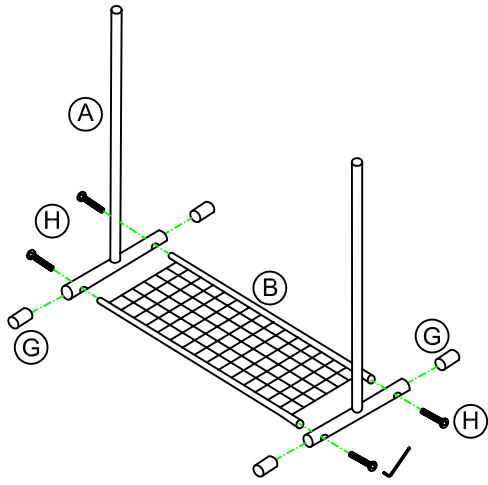

2

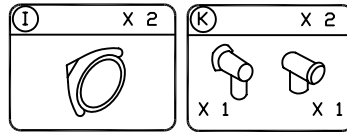
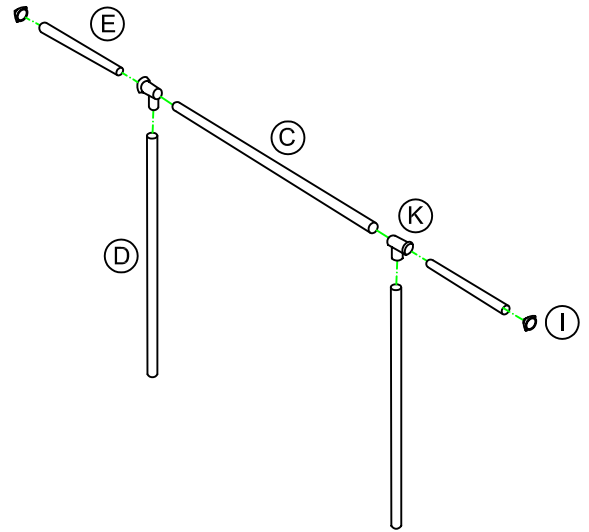

3

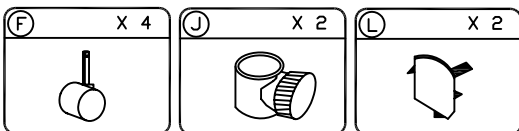
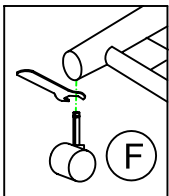
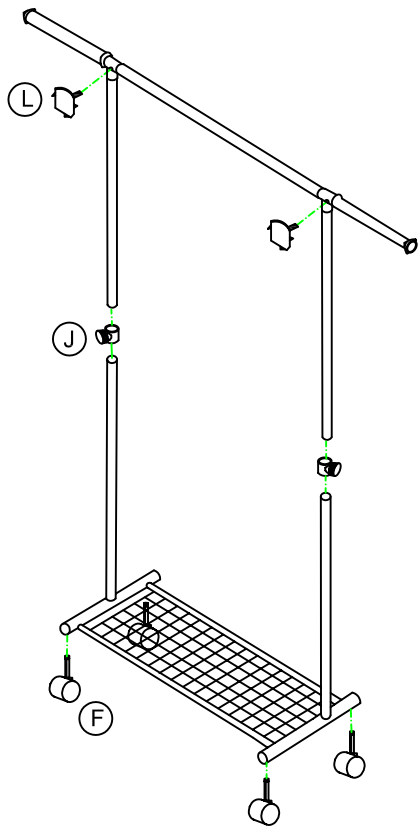

4

